

*FEHLING...*

*... THE DIFFERENCE*

4

FORCEPS,  
CLAMPS AND CLIPS

PINZETTEN,  
KLEMMEN UND CLIPS



**FEHLING**  
**INSTRUMENTS**

Hanauer Landstr. 7A · 63791 Karlstein/Germany · [www.fehling-instruments.de](http://www.fehling-instruments.de)



+49 (0) 61 88 - 9574.40



+49 (0) 61 88 - 9574.45



[info@fehling-instruments.de](mailto:info@fehling-instruments.de)



DE BAKEY

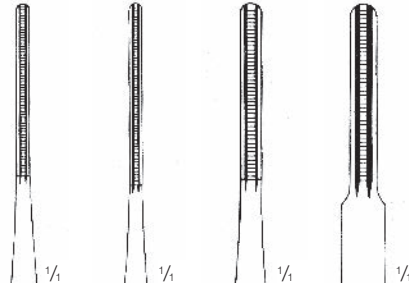

	1,5 mm	2,0 mm	2,8 mm	3,5 mm
150 mm	MBL-2	MBL-5	MBK-2	MBM-4
195 mm	MBL-3	MBL-6	MBK-3	MBM-5
240 mm	MBL-4	MBL-7	MBK-4	MBM-6
300 mm	–	–	MBL-8	MBM-7



DE BAKEY

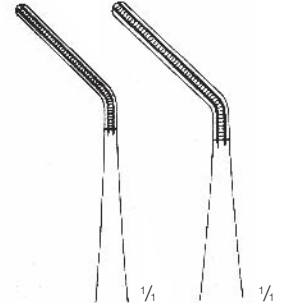

	2,0 mm	2,7 mm
150 mm	MBL-9	–
195 mm	MBM-1	–
240 mm	MBM-2	–
300 mm	–	MBM-3



TC DE BAKEY

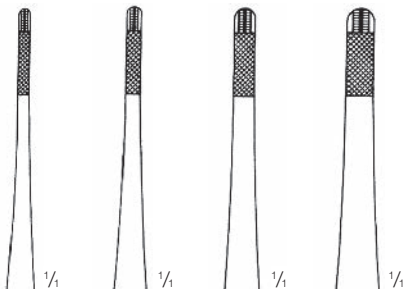

	1,5 mm	2,0 mm	2,7 mm	3,5 mm
150 mm	MEJ-2	MEJ-4	MEJ-7	–
195 mm	MDZ-1	MEJ-5	MEJ-8	MEK-1
240 mm	MEJ-3	MEJ-6	MEJ-9	MEK-2



1/2

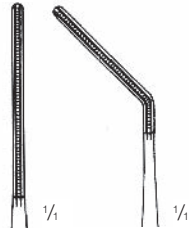

1/4

1/4

	1,5 mm	1,5 mm
150 mm	MBK-7	-
195 mm	MBK-8	MBL-1
240 mm	MBK-9	-

DE BAKEY  
DIETRICH



1/2



1/4

1/4

	1,0 mm	1,5 mm
150 mm	-	CDN-6
195 mm	CDK-7	-
240 mm	CDN-7	-

DE BAKEY  
ULTRA LIGHT



1/2

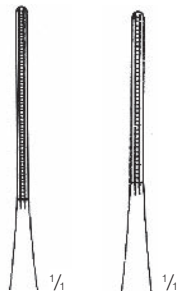

1/4

1/4

	1,5 mm	1,8 mm
150 mm	MBP-1	MED-3
195 mm	MBP-2	MED-4
240 mm	MBP-3	MED-5

DIETRICH  
TITANIUM / TITAN



1/2

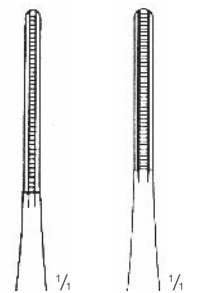

1/4

1/4

	2,0 mm	2,8 mm
150 mm	MFG-8	MBP-4
195 mm	MFG-9	MBP-5
240 mm	MFH-1	MBP-6

DIETRICH  
TITANIUM / TITAN



1/2

HEART VALVE FORCEPS  
HERZKLAPPENPINZETTE

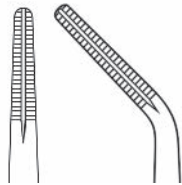

	2,5 mm	3,0 mm
200 mm	CDP-5	-
230 mm	CDP-2	CDP-7
250 mm	CDP-3	-



1/2

ADSON-BRAUN  
120 mm



1/4

CERAMO®	COX-0
UNCOATED UNBESCHICHTET	CAK-9

JEWELLER FORCEPS  
UHRMACHERPINZETTEN



110 mm

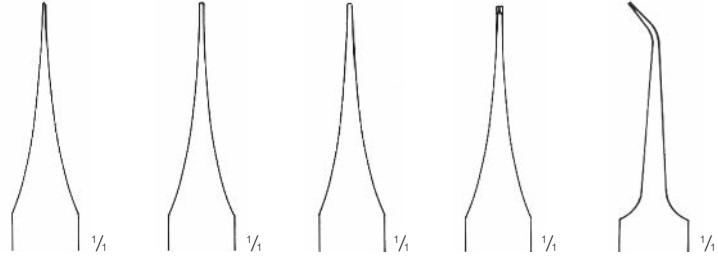

	0,1 mm	0,2 mm	0,4 mm	1x2 TEETH/ZÄHNE	0,25 mm
CERAMO®	-	COW-7	COW-8	-	-
UNCOATED UNBESCHICHTET	CAY-7	CAY-8	CAY-9	CAZ-2	CAZ-1



115 mm

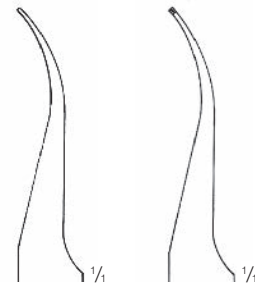

	0,2 mm	1x2 TEETH/ZÄHNE
CERAMO®	CRB-1	-
UNCOATED UNBESCHICHTET	CAY-6	CAZ-4



GERALD

CERAMO®	TCM 1,0 mm
150 mm	COK-0
180 mm	COK-1
210 mm	COK-2
230 mm	COK-3

UNCOATED UNBESCHICHTET	1,0 mm
180 mm	CAE-8
210 mm	CAF-0
230 mm	CAE-9



CUSHING  
175 mm

TCM  
1,5 mm  
CERAMO®  
COW-1

1,5 mm  
UNCOATED  
UNBESCHICHTET  
CBP-9



1/2

ADSON

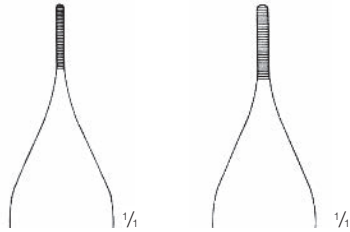

	MICRO / MIKRO 0,8 mm		1,2 mm	
	120 mm	150 mm	120 mm	150 mm
CERAMO®	COZ-9	COW-6	COZ-7	COZ-8
UNCOATED UNBESCHICHTET	CAA-5	CAA-6	CAA-2	CAA-3



1/2

TC ADSON



	1,4 mm
120 mm	CAZ-6
150 mm	CAZ-7



1/2

SEMKEN



	120 mm	150 mm
CERAMO®	COP-5	COP-6
UNCOATED UNBESCHICHTET	CAG-8	CAG-9



1/2

TC POTTS-SMITH



145 mm	CBA-7
180 mm	CBA-8
200 mm	CBA-9
230 mm	CBB-1
250 mm	CBB-2



1/2

STANDARD

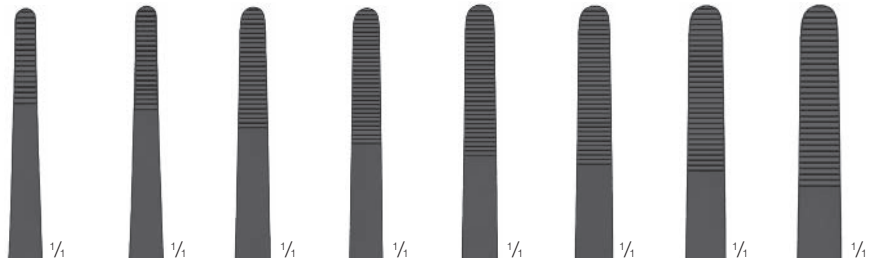

	115 mm	130 mm	145 mm	160 mm	180 mm	200 mm	250 mm	300 mm
CERAMO®	COR-1	COR-2	COR-3	COR-4	COR-5	COR-6	COR-7	COR-8
UNCOATED UNBESCHICHTET	CAA-9	CAB-1	CAB-2	CAB-3	CAB-4	CAB-5	CAB-6	CAB-7



1/2

DELICATE  
SCHLANK

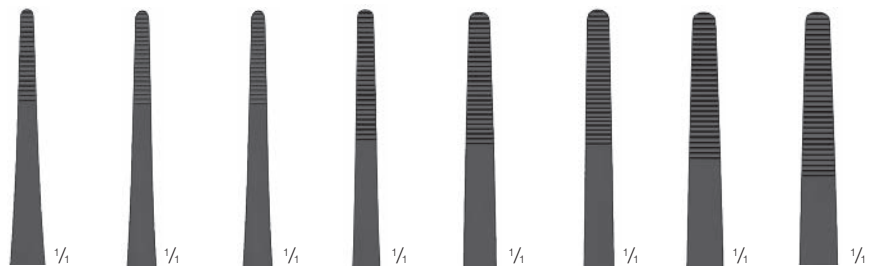

	115 mm	130 mm	145 mm	160 mm	180 mm	200 mm	250 mm	300 mm
CERAMO®	COZ-O	COZ-1	COR-9	COZ-2	COZ-3	COZ-4	COZ-5	COZ-6
UNCOATED UNBESCHICHTET	CAC-3	CAC-4	CAC-5	CAC-6	CAC-7	CAC-8	CAC-9	CAD-1





1/2

ADSON

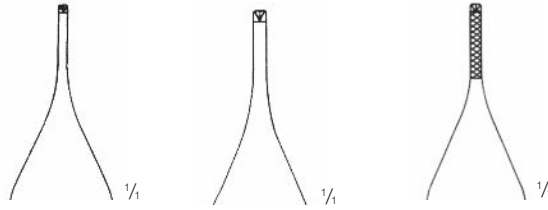

	1x2 TEETH / ZÄHNE					
	MICRO / MIKRO 0,8 mm		1,2 mm		TC 1,8 mm	
	120 mm	150 mm	120 mm	150 mm	120 mm	150 mm
CERAMO®	COW-4	COW-5	COW-3	COW-9	-	-
UNCOATED UNBESCHICHTET	CAL-1	CAL-2	CAK-7	CAK-8	CAZ-8	CAZ-9



1/2

RUSSIAN PATTERN  
RUSSISCHES MODELL



1/2

SEMKEN

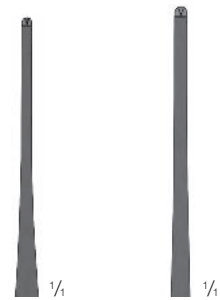

	1x2 TEETH / ZÄHNE	
	125 mm	150 mm
CERAMO®	COP-8	COP-7
UNCOATED UNBESCHICHTET	CAU-9	CAV-1

	150 mm	200 mm	250 mm
CERAMO®	COW-2	-	-
UNCOATED UNBESCHICHTET	CAU-3	CAU-4	CAU-5

1x2 TEETH / ZÄHNE



1/2

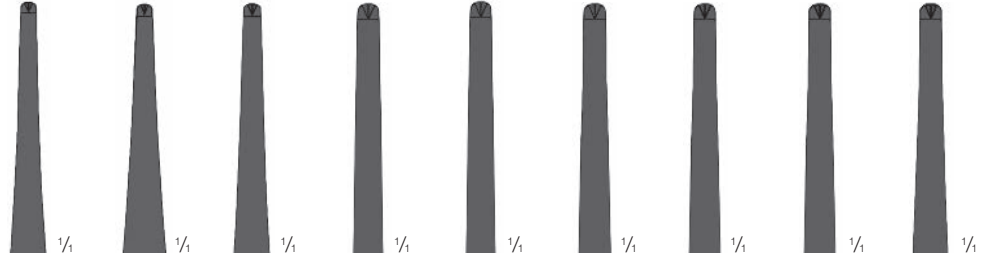

	105 mm	115 mm	130 mm	145 mm	160 mm	180 mm	200 mm	250 mm	300 mm
CERAMO®	CZD-1	CZD-2	CZD-3	CZD-4	CZD-5	CZB-1	CZD-7	CZD-8	CZD-9
UNCOATED UNBESCHICHTET	CAL-5	CAL-6	CAL-7	CAL-8	CAL-9	CAM-1	CAM-2	CAM-4	CAM-5

STANDARD

1x2 TEETH / ZÄHNE



1/2

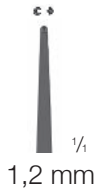

1,2 mm



1/2

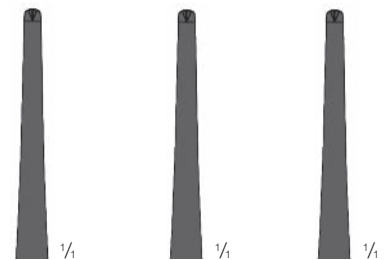

	145 mm	160 mm	250 mm
CERAMO®	CZB-8	CZB-9	COP-9
UNCOATED UNBESCHICHTET	CAP-9	CAR-1	CAP-8

MEDIUM

1x2 TEETH / ZÄHNE

	150 mm	180 mm	210 mm	230 mm
CERAMO®	COI-1	COI-2	COI-3	COI-4
UNCOATED UNBESCHICHTET	-	CAS-8	CAS-9	CAT-1

GERALD



DELICATE  
SCHLANK

1x2 TEETH / ZÄHNE

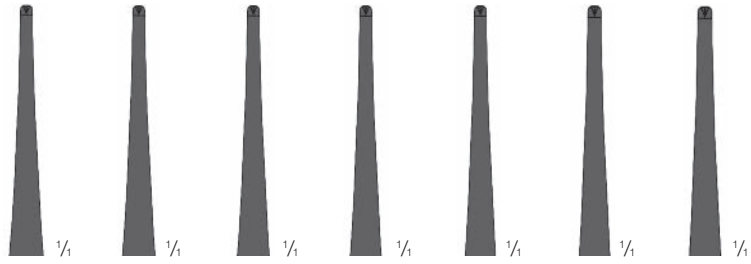

	115 mm	130 mm	145 mm	160 mm	180 mm	200 mm	250 mm
CERAMO®	CZB-4	CZB-5	CZB-3	CZB-6	CZB-7	-	-
UNCOATED UNBESCHICHTET	CAN-9	CAP-1	CAP-2	CAP-3	CAP-4	CAP-5	CAP-7



200 mm

2x3 TEETH / ZÄHNE

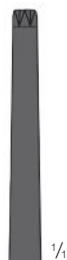

CERAMO®	CZB-2
UNCOATED UNBESCHICHTET	CAN-2



3x4 TEETH / ZÄHNE

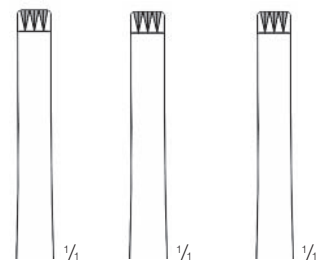

145 mm	160 mm	300 mm
CAN-5	CAN-6	CAN-7

CLIP APPLYING FORCEPS  
CLIPANLEGEZANGEN



CERAMO®

FOR / FÜR YASARGIL  
+ SUGITA CLIPS

		CLIP ROTATABLE / DREHBAR	
			
TOTAL LENGTH GESAMTLÄNGE		230 mm	270 mm
LENGTH a LÄNGE a		80 mm	120 mm
CLIP SIZE CLIP GRÖßE	MINI	TOQ-9	TOQ-7
	STANDARD	TOQ-8	TOQ-6

SHAFT ROTATABLE  
SCHAFT DREHBAR



MEMORY

FOR / FÜR YASARGIL + SUGITA CLIPS

		CLIP FIXED / STARR			CLIP ROTATABLE / DREHBAR		
							
LENGTH a LÄNGE a		70 mm	90 mm	110 mm	70 mm	90 mm	110 mm
CLIP SIZE CLIP GRÖßE	MINI	NIB-1	NIB-2	NIB-3	NIB-7	NIB-8	NIB-9
	STANDARD	NIC-0	NIC-1	NIB-0	NIB-4	NIB-5	NIB-6

The shafts of MEMORY clip applying forceps are constructed of shape-memory metal. They are malleable in normal O.R. temperatures. Soft pressure allows "permanent" deformation of shape according to the surgeon's needs. However in higher temperatures, such as those found in the autoclave, the instruments regain their initial shape.

MEMORY Clipanlegezangen haben einen Schaft aus Formgedächtnismetall. Sie sind bei normaler OP-Temperatur biegsam. Sie können durch sanften Druck in die gewünschte Form gebracht werden. Unter höheren Temperaturen, wie bei der Sterilisation, nehmen sie ihre ursprüngliche Form wieder an.

TCM SCHWARTZ

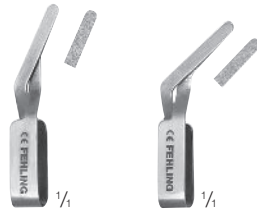

PRESSURE DRUCK	25°	45°
ca. 5,0 N	MIC-6	MIC-7
ca. 7,8 N	MIC-4	MIC-5



SCHWARTZ  
CLIP APPLYING FORCEPS  
CLIPANLEGEZANGE  
190 mm  
MBC-9

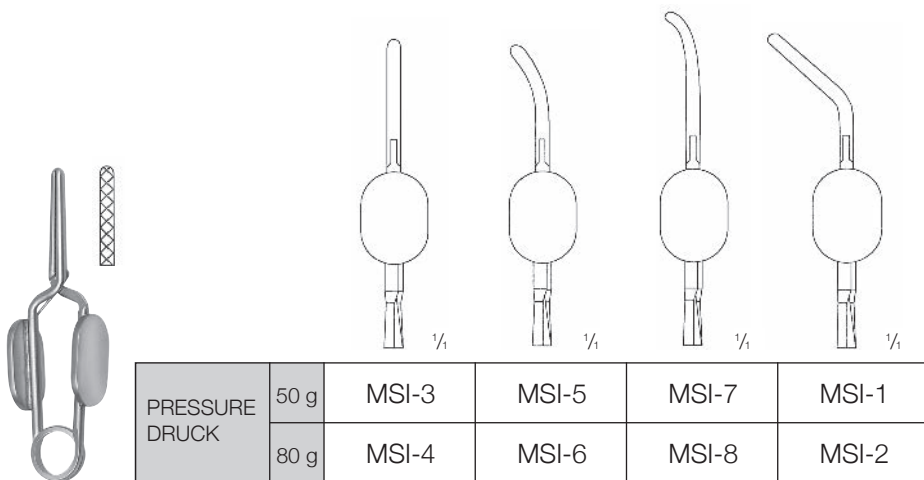

PRESSURE DRUCK	50 g	MSI-3	MSI-5	MSI-7	MSI-1
	80 g	MSI-4	MSI-6	MSI-8	MSI-2

MUELLER  
NON-TRAUMATIC  
ATRAUMATISCH



CLIP APPLYING FORCEPS  
CLIPANLEGEZANGE

140 mm	DBA-3
180 mm	DBA-4
220 mm	DBA-5

TITANIUM



V (Vena) = low pressure  
V (Vena) = schwacher Druck  
1 N ± 10%



A (Arteria) = high pressure  
A (Arteria) = starker Druck  
2 N ± 20%



IDENTIFICATION KENNZEICHNUNG	V = VENA	A = ARTERIA	V = VENA	A = ARTERIA	V = VENA	A = ARTERIA	V = VENA	A = ARTERIA
ITEM. - NO. ART. - NR.	MMA-1	MKS-9	MMF-7	MML-6	MKT-1	MKE-5	MML-8	MML-7
TOTAL LENGTH GESAMTLÄNGE	30 mm		35 mm		40 mm		50 mm	
LENGTH OF JAW MAULLÄNGE	9 mm		13 mm		14 mm		23 mm	
WEIGHT GEWICHT	1 gr.		1 gr.		1 gr.		1,5 gr.	

**TITANIUM**



IDENTIFICATION KENNZEICHNUNG	V = VENA	A = ARTERIA	V = VENA	A = ARTERIA	V = VENA	A = ARTERIA	V = VENA	A = ARTERIA
ITEM. - NO. ART. - NR.	MMF-8	MMA-9	MMA-8	MMB-1	MML-9	MMB-2	MMF-3	MMB-3
TOTAL LENGTH GESAMTLÄNGE	30 mm		35 mm		40 mm		48 mm	
LENGTH OF JAW MAULLÄNGE	9 mm		13 mm		14 mm		22 mm	
WEIGHT GEWICHT	1 gr.		1 gr.		1 gr.		1,5 gr.	



IDENTIFICATION KENNZEICHNUNG	V = VENA	A = ARTERIA	V = VENA	A = ARTERIA	V = VENA	A = ARTERIA	V = VENA	A = ARTERIA
ITEM. - NO. ART. - NR.	MMM-2	MMM-1	MMF-4	MMF-5	MMM-4	MMM-3	MMA-2	MKT-2
TOTAL LENGTH GESAMTLÄNGE	30 mm		35 mm		40 mm		45 mm	
LENGTH OF JAW MAULLÄNGE	10 mm		14 mm		15 mm		21 mm	
WEIGHT GEWICHT	1 gr.		1 gr.		1 gr.		1,5 gr.	



WELDON



35 mm



STRAIGHT GERADE	CURVED GEBOGEN	ACUTELY CURVED STARK GEBOGEN	ANGLED GEWINKELT
MAZ-7	MAZ-9	MBA-2	MEE-9



45 mm

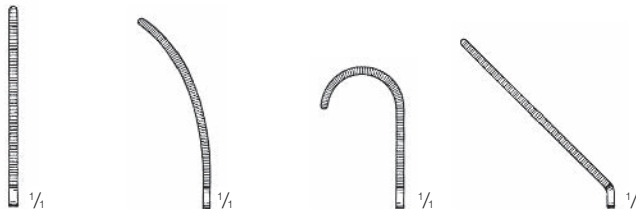

STRAIGHT GERADE	CURVED GEBOGEN	ACUTELY CURVED STARK GEBOGEN	ANGLED GEWINKELT
MAZ-8	MBA-1	MEE-8	MBA-4



APPLYING FORCEPS FOR  
SPRING BULLDOG CLAMPS  
ANLEGEZANGE FÜR  
FEDERBULLDOGKLEMMEN

MMM-0

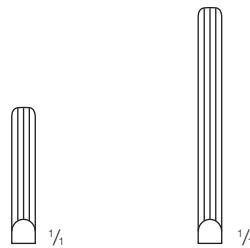

JAW LENGTH MAULLÄNGE	18 mm	28 mm
TOTAL LENGTH GESAMTLÄNGE	42 mm	52 mm
	MBC-0	MBA-0



TCM IMA  
55 mm

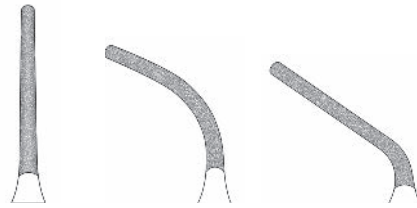

STRAIGHT GERADE	CURVED GEBOGEN	ANGLED GEWINKELT
MRK-1	MRK-2	MRK-3



DIETHRICH  
55 mm

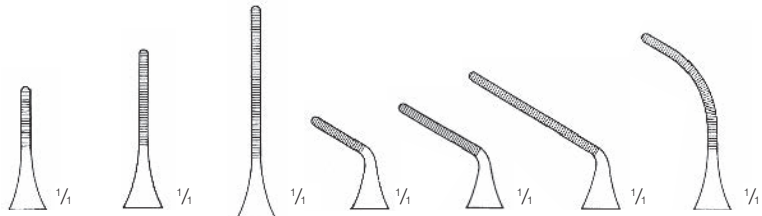

JAW LENGTH MAULLÄNGE	8 mm	12 mm	20 mm	8 mm	12 mm	20 mm	20 mm
PRESSURE: 0,8 N DRUCK: 0,8 N	MEF-1	MEC-2	MAW-6	MAW-7	MAW-8	MAX-1	MAW-5



GREGORY  
"SOFT" CAROTID CLAMPS  
"SOFT" CAROTIS KLEMMEN



JAW LENGTH MAULLÄNGE	60 mm	60 mm	27 mm	44 mm	55 mm	60 mm
TOTAL LENGTH GESAMTLÄNGE	110 mm	110 mm	90 mm	110 mm	105 mm	110 mm
	MNI-7	MNI-6	MNJ-1	MNJ-2	MNJ-3	MNJ-4

DE BAKEY

NON-TRAUMATIC  
ATRAUMATISCH



1/4

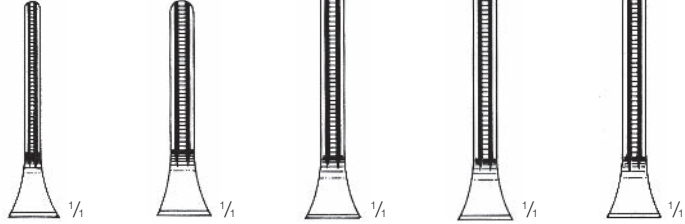

TOTAL LENGTH GESAMTLÄNGE	55 mm	75 mm	90 mm	105 mm	120 mm
PRESSURE / DRUCK: 1,8 N	MAM-5	MAM-6	MAM-7	MAM-8	MAM-9
PRESSURE / DRUCK: 2,8 N	MAO-1	-	-	-	-



1/4

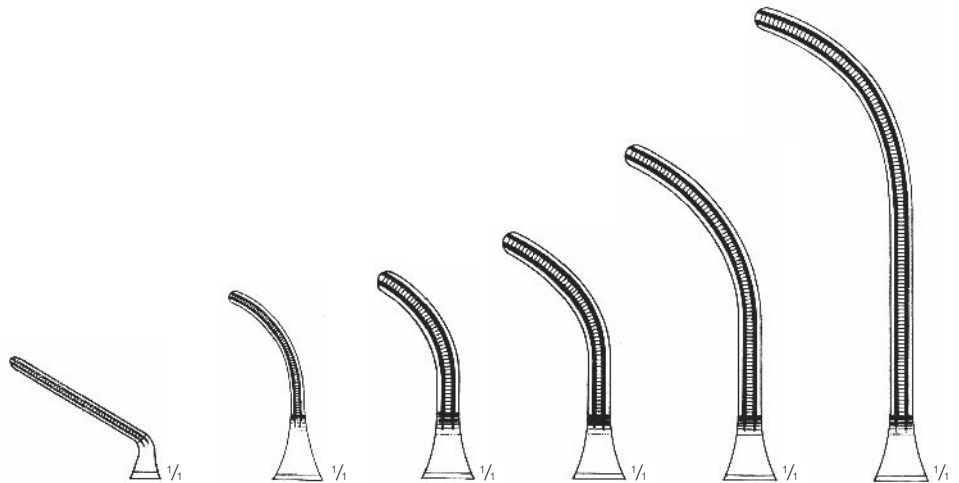

TOTAL LENGTH GESAMTLÄNGE	55 mm	55 mm	75 mm	85 mm	105 mm	120 mm
PRESSURE / DRUCK: 1,8 N	MAM-4	MAN-2	MAN-3	MAN-4	MAN-5	MAN-6
PRESSURE / DRUCK: 2,8 N	MAO-3	MAO-2	-	-	-	-

**TITANIUM**

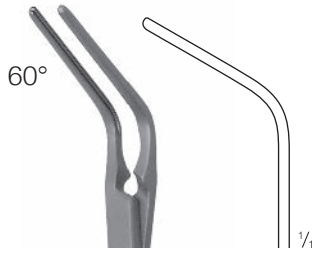

MHN-1

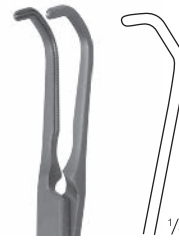

6 mm  
MHN-2



MHN-9



DE BAKEY  
105 mm



6 mm  
MHN-3



DE BAKEY  
105 mm



9 mm  
MHN-4



DE BAKEY  
105 mm

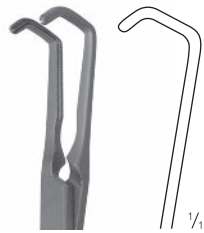

6 mm  
MHO-3



SEBENING  
105 mm



9 mm  
MHO-4

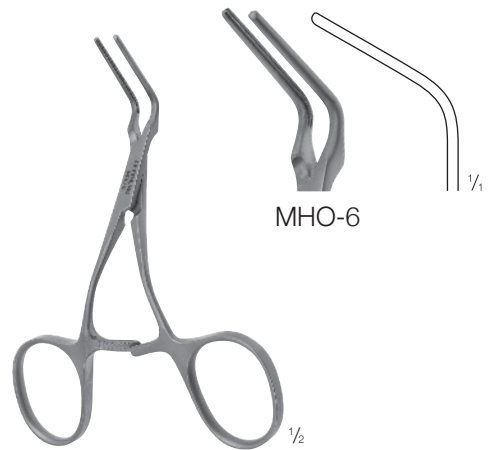

SEBENING  
105 mm

MHO-6

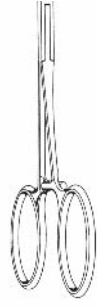

125 mm	145 mm	165 mm
MAC-2	MAE-7	MAH-2
MER-4	MDV-9	MER-5

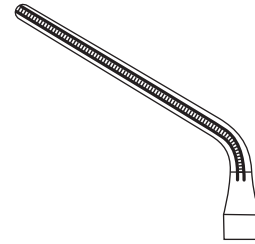

125 mm	145 mm	165 mm
MAC-4	MAE-9	MAH-4
MER-8	MDW-2	MER-9



125 mm	145 mm	165 mm
MAC-5	MAF-1	MAH-5
MES-1	MES-2	MES-3

TITANIUM  
TITAN

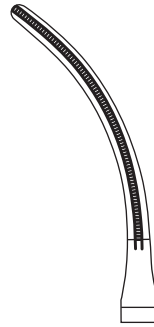

125 mm	145 mm	165 mm
MAD-1	MAF-6	MAJ-1
MET-4	MET-5	MET-6



125 mm	145 mm	165 mm
MAC-9	MAF-5	MAH-9
MDT-8	MDU-2	MDU-5

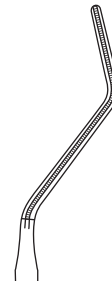
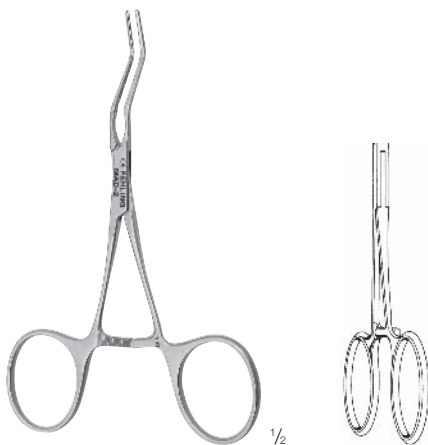

125 mm	145 mm	165 mm
MAD-2	MAF-7	MAJ-2
MET-7	MET-8	MET-9

TITANIUM  
TITAN

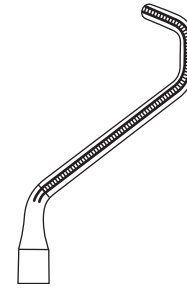

125 mm	145 mm	165 mm
MAC-8	MAF-4	MAH-8
MET-1	MET-2	MET-3

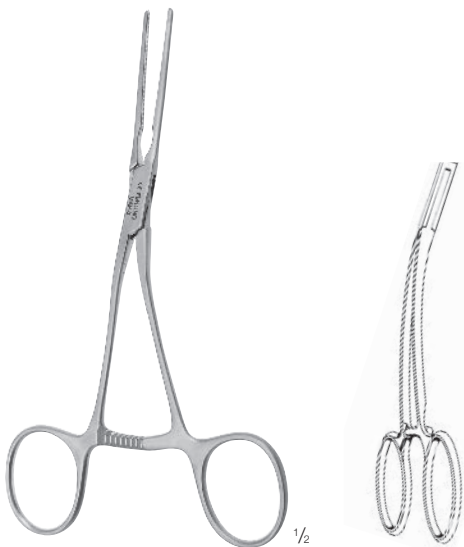

125 mm	145 mm	165 mm
MAD-3	MAF-8	MAJ-3
MEU-1	MEU-2	MEU-3



125 mm	145 mm	165 mm
MAC-6	MAF-2	MAH-6
MES-4	MES-5	MES-6

TITANIUM  
TITAN

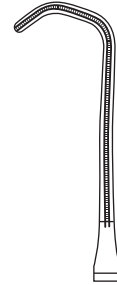

125 mm	145 mm	165 mm
MAC-7	MAF-3	MAH-7
MES-7	MES-8	MES-9

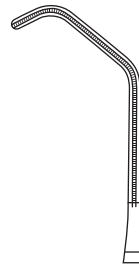

125 mm	145 mm	165 mm
MAD-9	MAG-5	MAJ-9
MEU-9	MEV-1	MEV-2



125 mm	145 mm	165 mm
ZAE-6	ZAF-7	ZAF-4

TITANIUM  
TITAN





125 mm	145 mm	165 mm
MAC-3	MAE-8	MAH-3
MER-6	MDW-1	MER-7

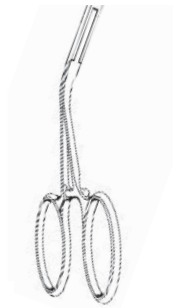

125 mm	145 mm	165 mm
MAD-4	MAF-9	MAJ-4
MEU-4	MEU-5	MFA-1

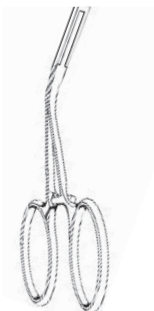
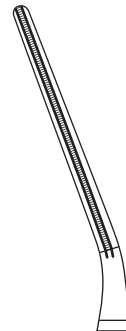

125 mm	145 mm	165 mm
MAE-3	MAG-8	MAK-3
MEV-3	MEV-4	MDW-5

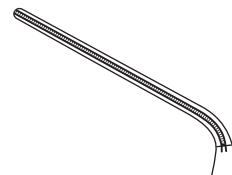

TITANIUM  
TITAN



125 mm	145 mm	165 mm
MAD-6	MAG-2	MAJ-6
MEU-6	MEU-7	MEU-8

 TITANIUM  
TITAN

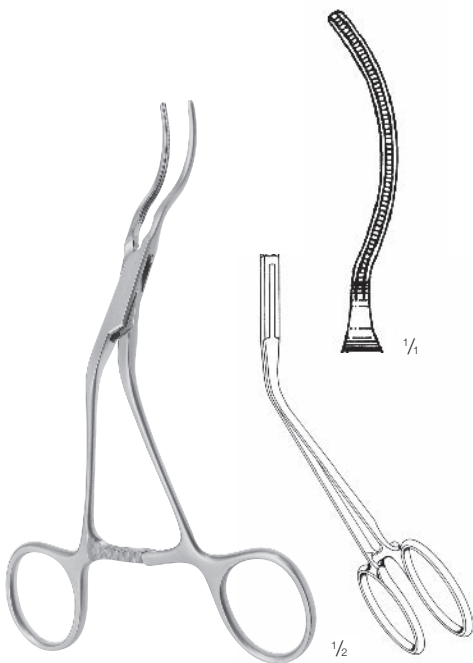

155 mm  
MAH-0

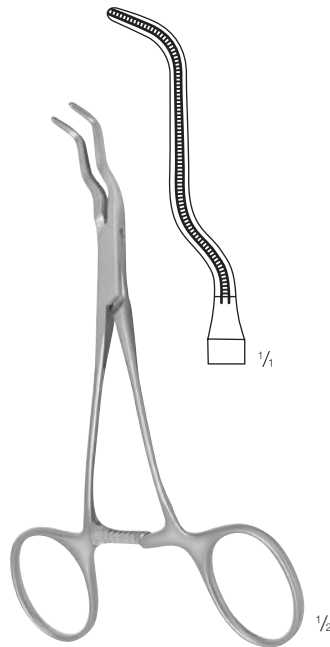

KITZMILLER  
140 mm  
MHD-3

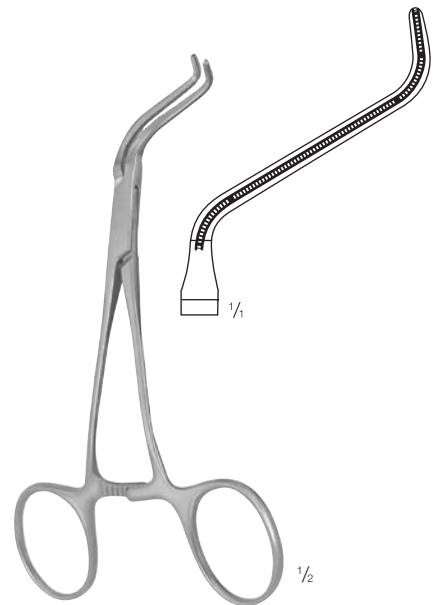

KITZMILLER  
140 mm  
MHD-4

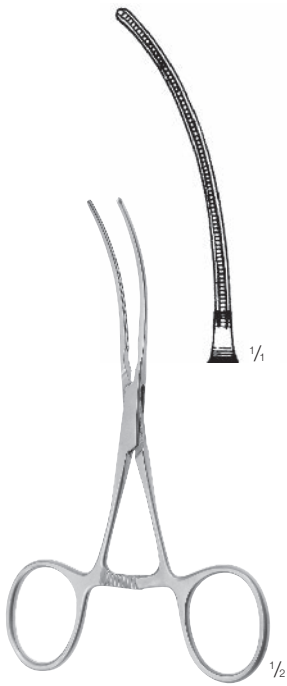

130 mm  
MAE-4

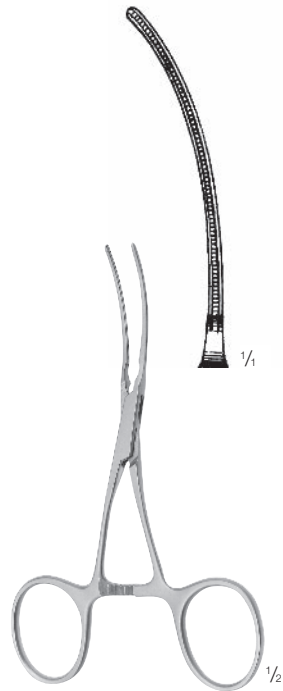

130 mm  
MAE-6

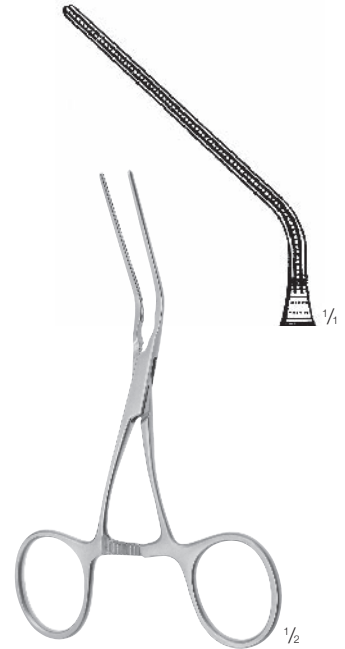

130 mm  
MAE-5

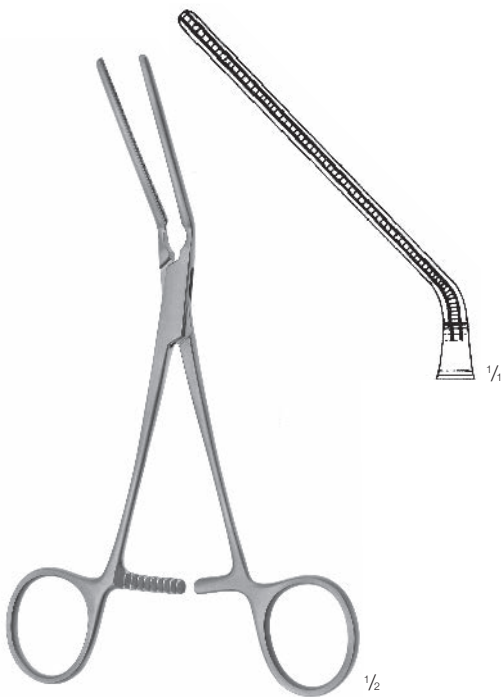

TITANIUM  
175 mm  
MDU-7



DE BAKKEY  
100 mm  
MED-9

DE BAKEY

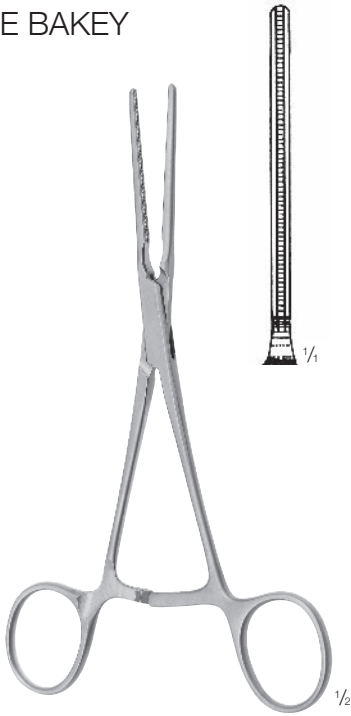

170 mm
MAP-8
MBD-1

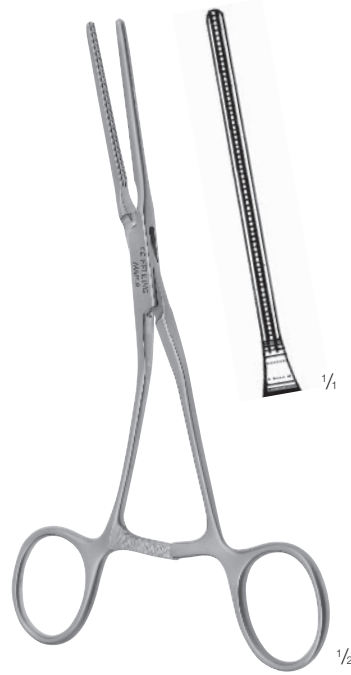

165 mm
MAP-9
MBD-8

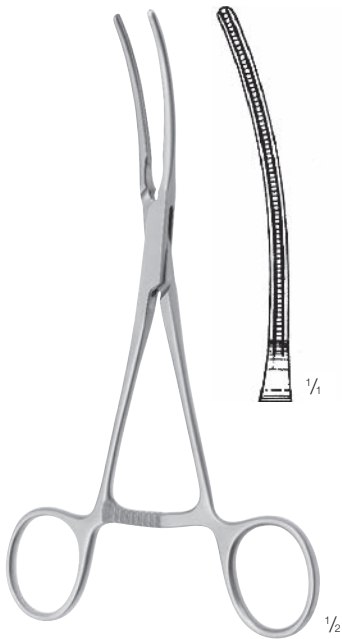

170 mm
MAC-1
MEO-7

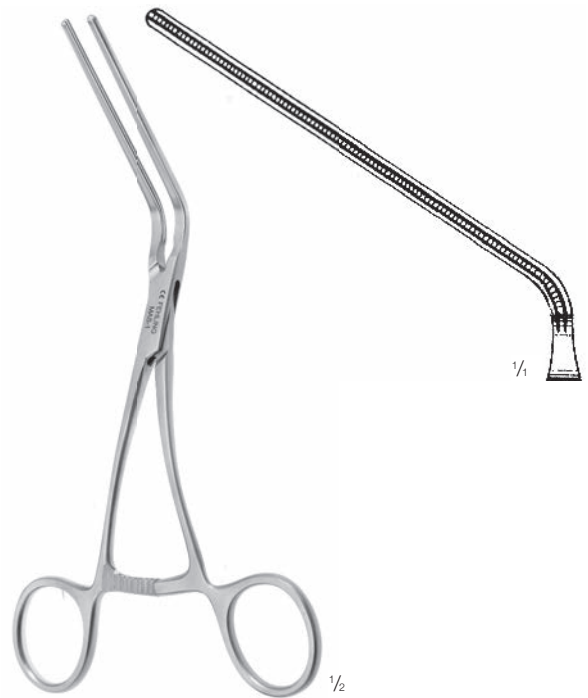

180 mm
MAS-1
MBF-2

DE BAKEY

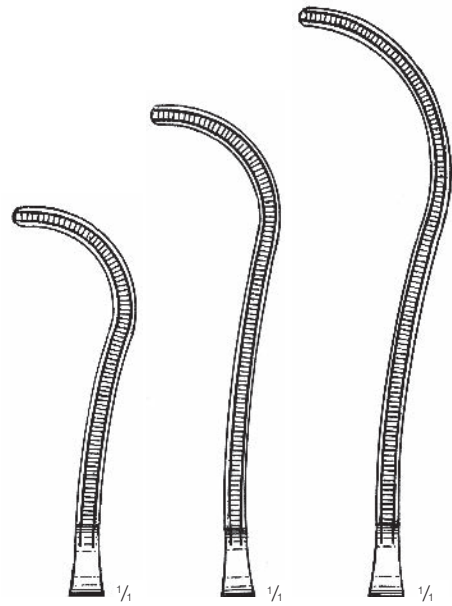

200 mm	220 mm	230 mm
MAV-1	MAV-2	MAR-5
MEO-8	MEP-1	MEO-9

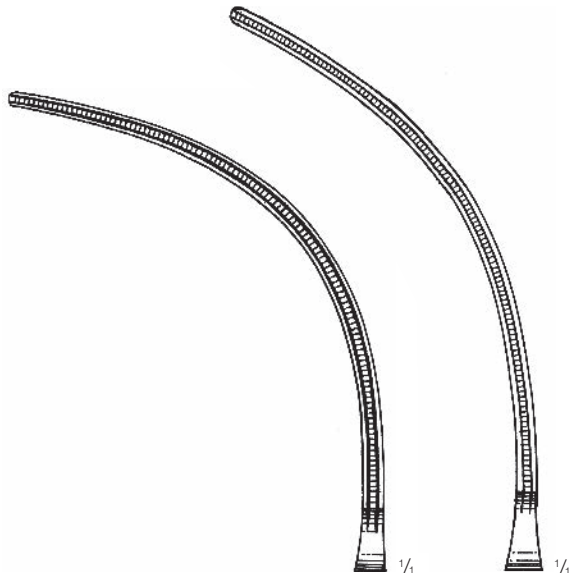

185 mm	200 mm
MAR-2	MAR-4
MEP-4	MEP-9

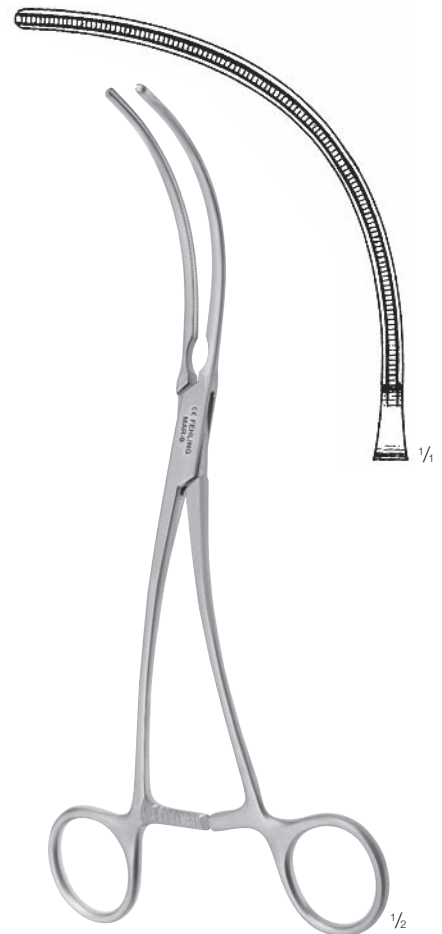

220 mm  
MAR-9

WYLIE

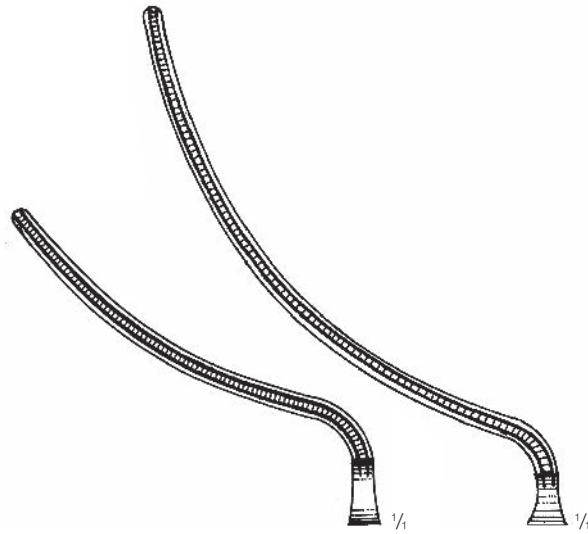

160 mm	185 mm
MEA-4	MEA-6

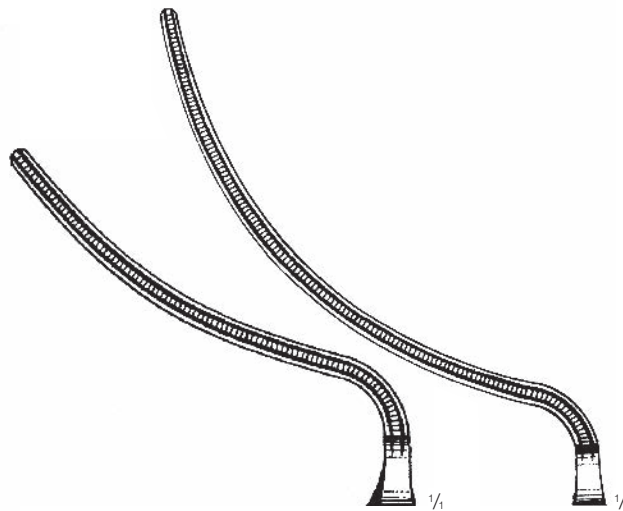

170 mm	200 mm
MEA-5	MEA-7

DE BAKEY



1/2

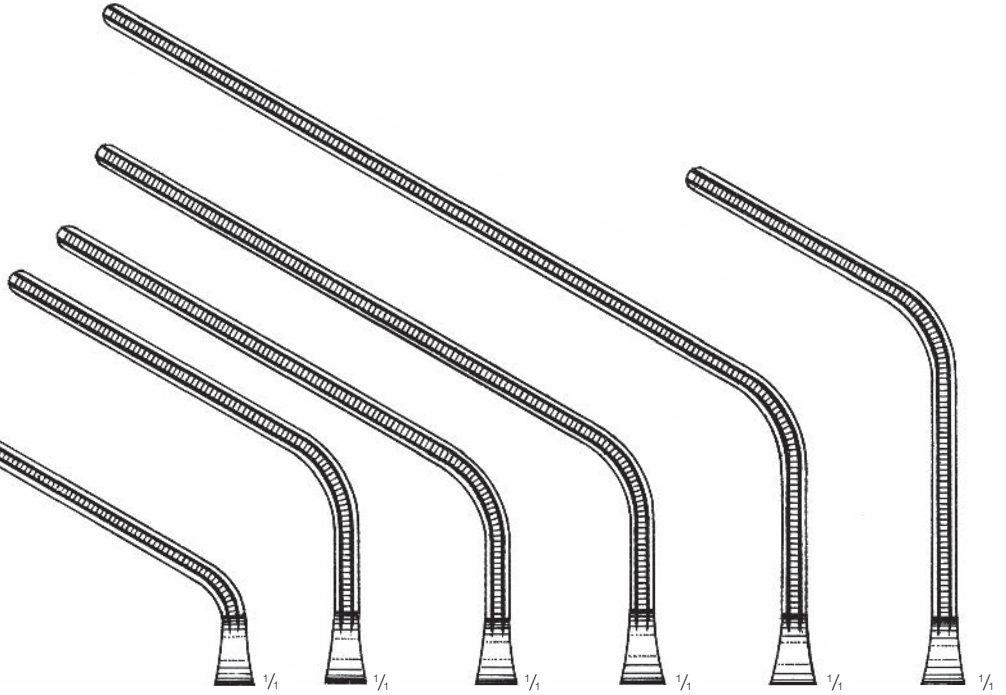

225 mm	230 mm	235 mm	280 mm	310 mm	240 mm
MHD-5	MAS-7	MAS-9	MHD-7	MAT-1	MAS-8



1/2

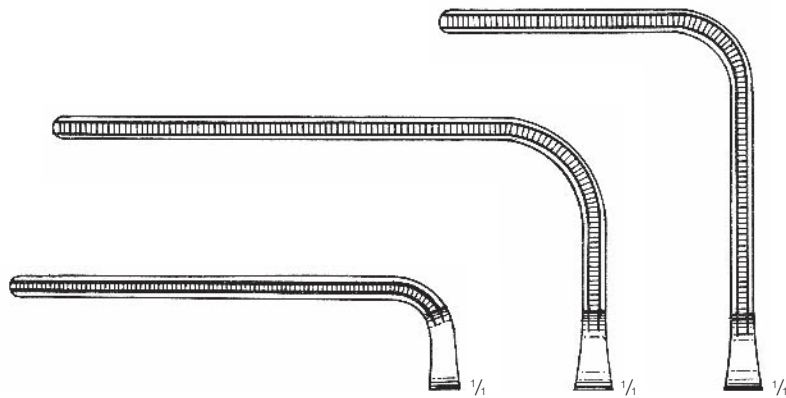

190 mm	255 mm	230 mm
MDV-7	MAS-5	MAS-4



DE BAKEY BORST

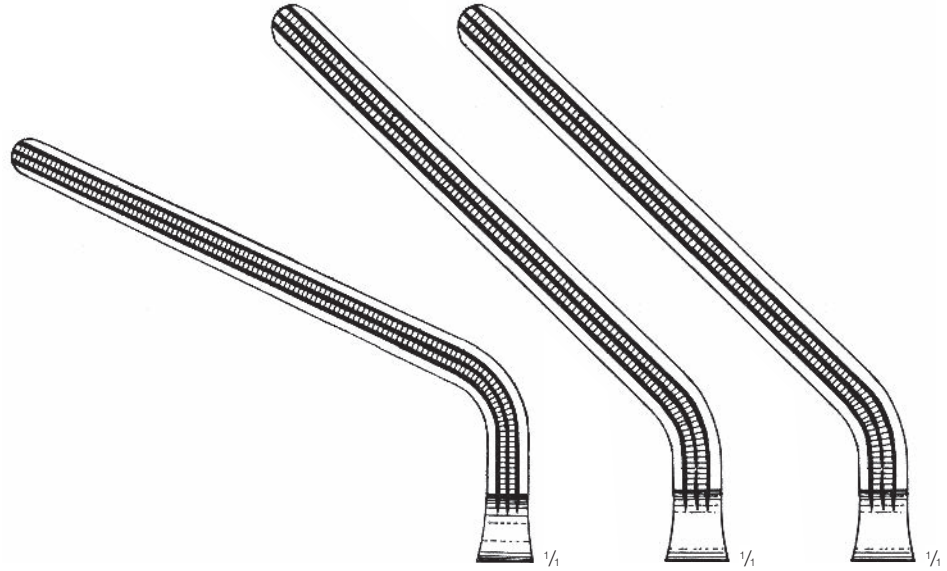

200 mm	230 mm	250 mm
MAU-3	MHF-6	MAU-4



LELAND-JONES  
190 mm

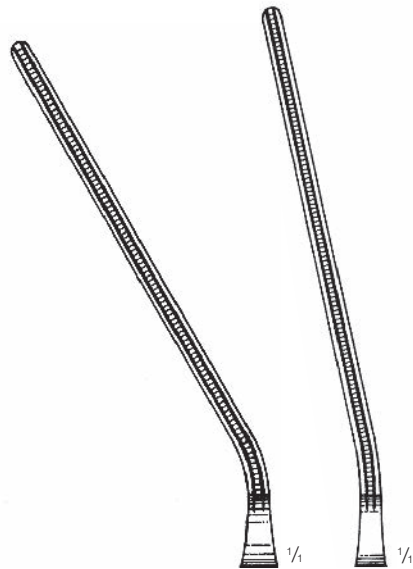

MAZ-5	MAZ-6
MEC-1	MED-6

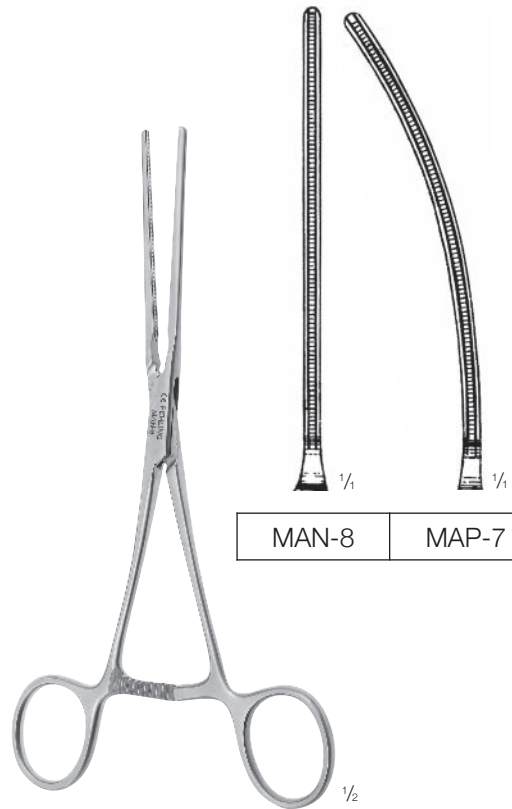

DE BAKEY BAINBRIDGE  
180 mm



DE BAKEY

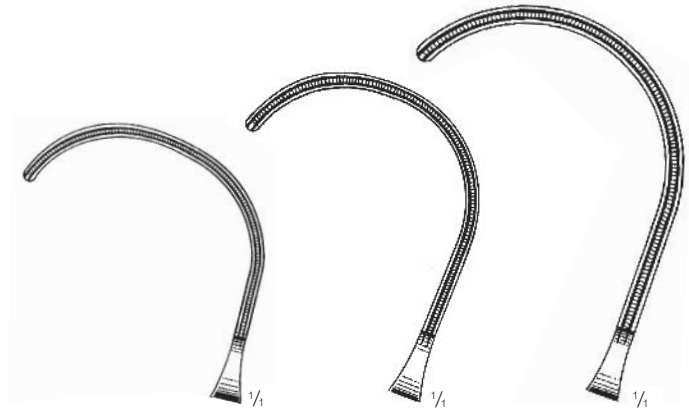

140 mm	160 mm	170 mm
MAX-6	MAX-7	MAX-8

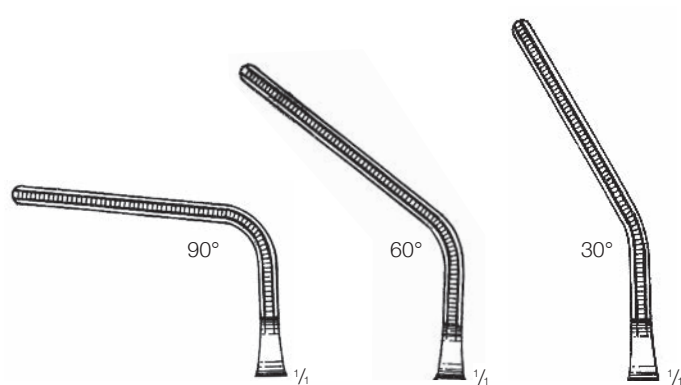

150 mm	160 mm	170 mm
MHC-7	MHC-9	MHC-8
MFR-1	MBF-1	MBE-1

DE BAKEY

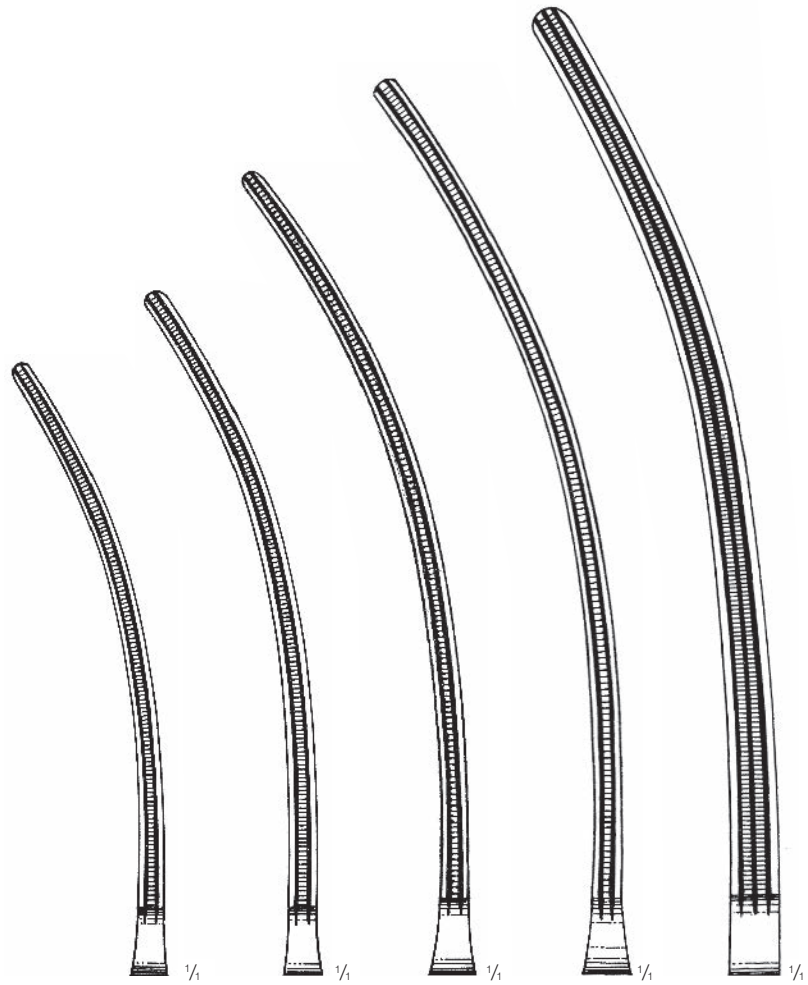

255 mm	265 mm	300 mm	310 mm	2x3 TEETH 2x3 ZÄHNE 320 mm
MAA-9	MAB-1	MAB-2	MAB-3	MFR-6
MFR-2	MFR-3	MFR-4	MFR-5	MEP-8

ANEURYSM AND ANASTOMOSIS CLAMPS  
ANEURYSMA- UND ANASTOMOSENKLEMMEN



GLOVER  
215 mm

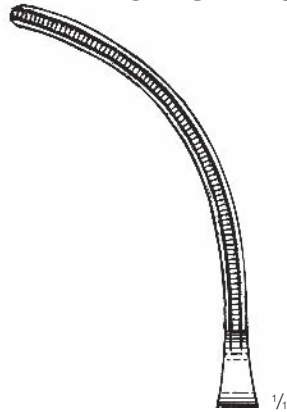

MAY-1  
MBD-3

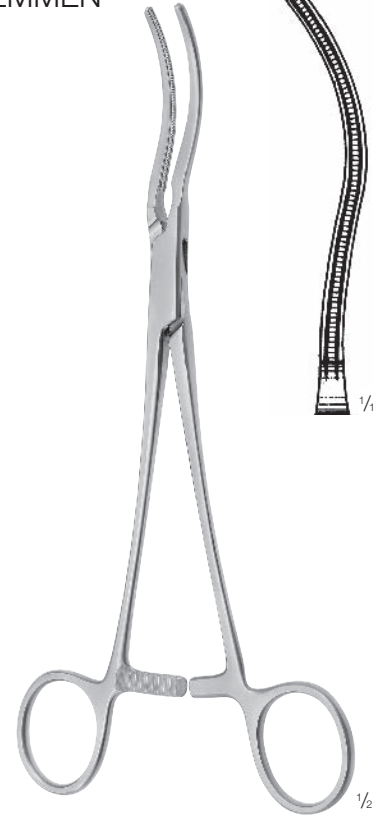

GLOVER  
220 mm  
MAY-2



LAMBERT-KAY

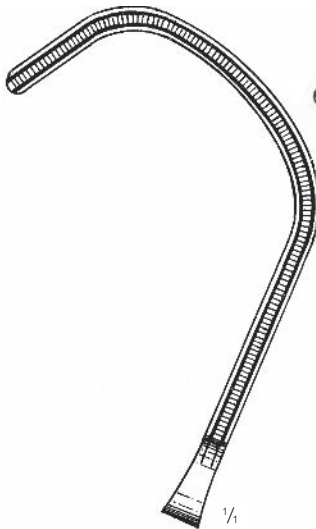

200 mm	255 mm
MAU-5	MBA-8



200 mm
MBF-5



COOLEY  
TITANIUM / TITAN  
185 mm  
MDW-3



ANEURYSM AND ANASTOMOSIS CLAMPS  
ANEURYSMA- UND ANASTOMOSENKLEMMEN



DERRA

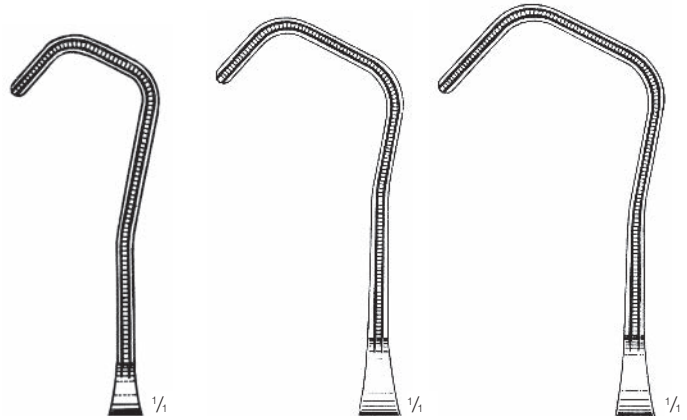

160 mm	170 mm	180 mm
MAV-5	MAV-4	MAB-9
MBE-2	MBE-3	MBE-4



COOLEY  
160 mm

MAK-9

TITANIUM  
TITAN



DE BAKEY

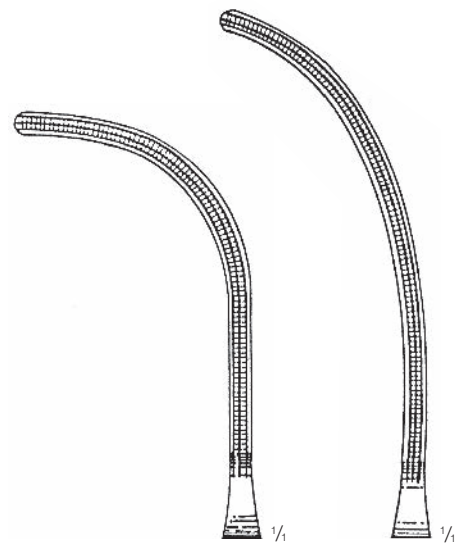

2x3 TEETH / ZÄHNE	
255 mm	265 mm
MKK-9	MKK-8

SATINSKY

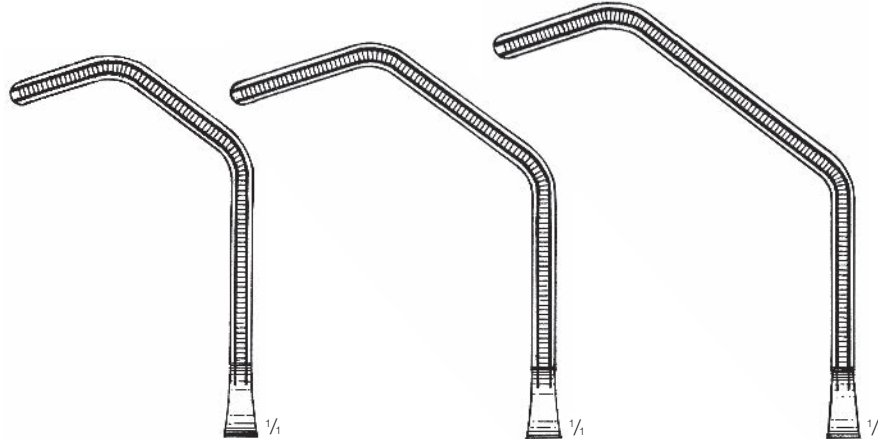

1	2	3
210 mm	260 mm	265 mm
MBB-8	MBB-9	MBC-1
MBE-5	MBE-6	MBE-7

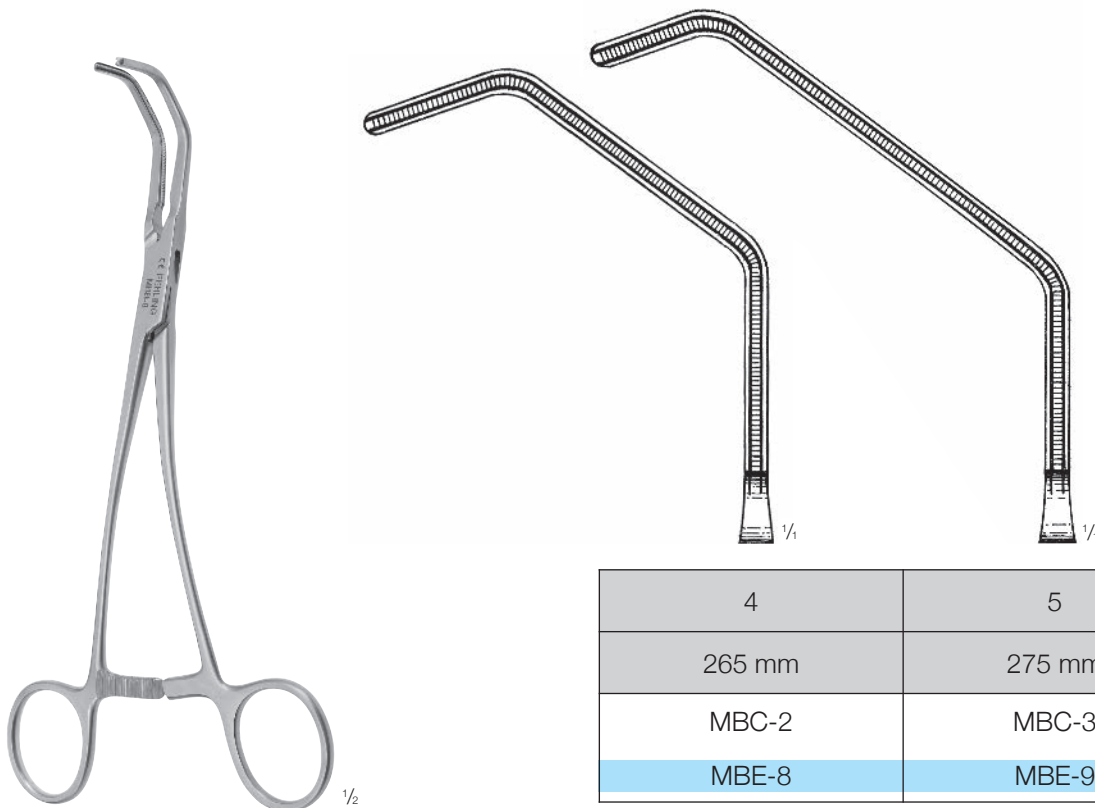

4	5
265 mm	275 mm
MBC-2	MBC-3
MBE-8	MBE-9

ANASTOMOSIS FORCEPS  
ANASTOMOSENKLEMMEN



DALE

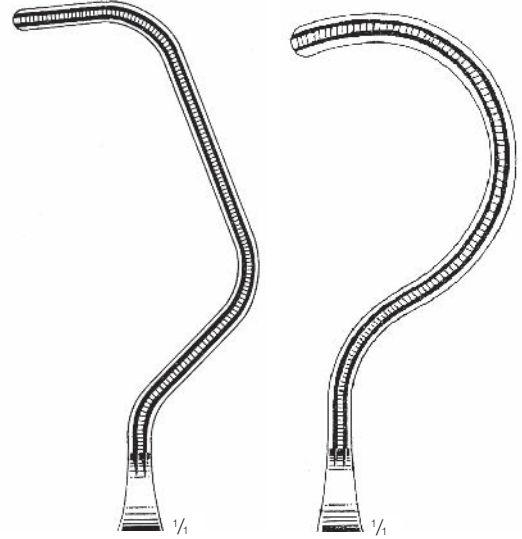

180 mm	190 mm
MAX-2	MAX-3



PARSONETT

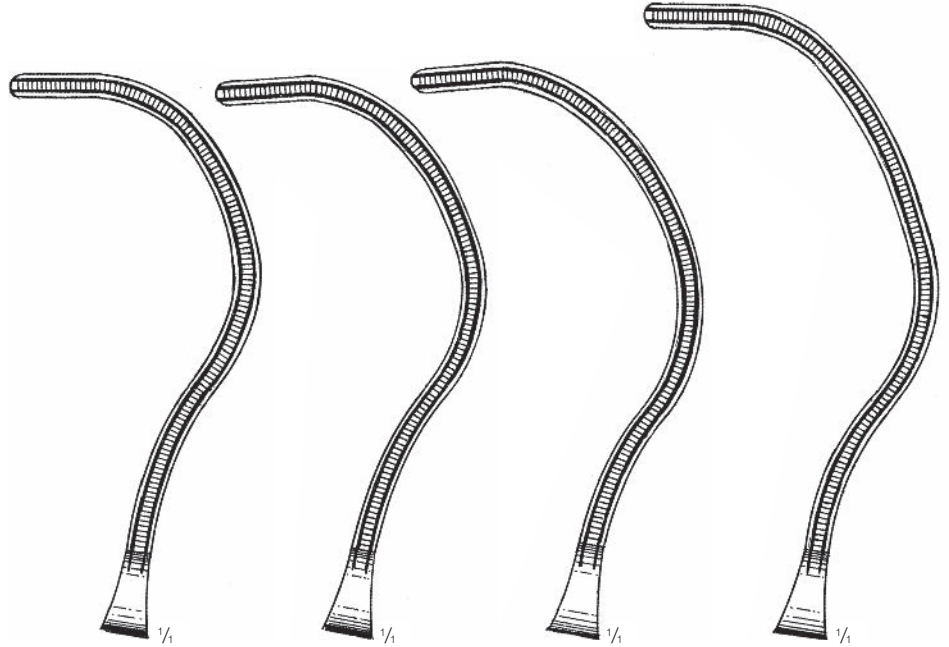

250 mm	260 mm	260 mm	265 mm
MBB-1	MBB-2	MEK-7	MBB-3

ATRIAL / ANASTOMOSIS FORCEPS  
VORHOF-/ANASTOMOSENKLEMMEN



RIGHT PATTERN  
RECHTSMODELL  
250 mm  
MLC-7

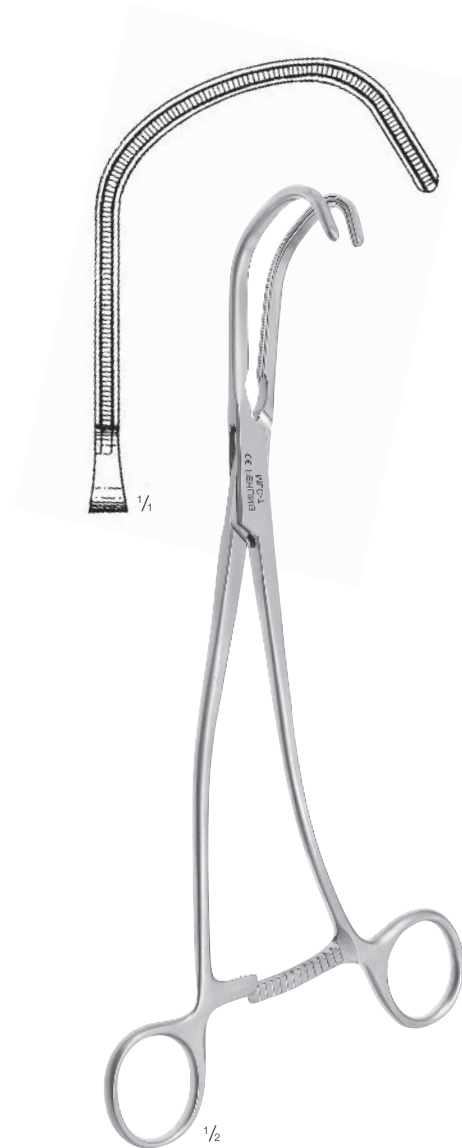

LEFT PATTERN  
LINKSMODELL  
250 mm  
MLC-6

CLAMPS FOR THE PARTIAL OCCLUSION OF THE AORTA AND THE AORTIC ARC  
KLEMMEN FÜR DEN PARTIELLEN VERSCHLUSS DER AORTA UND DES AORTENBOGENS

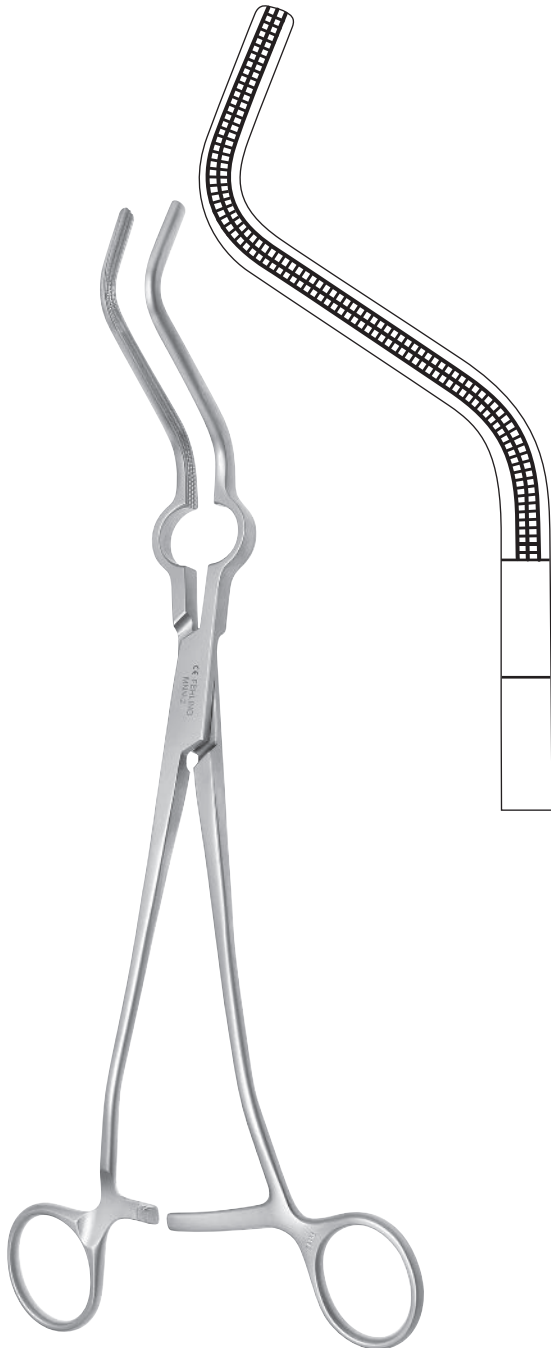

BIRNBAUM

JAW LENGTH MAULLÄNGE	TOTAL LENGTH GESAMTLÄNGE	
50 x 30 mm	310 mm	MNN-2
60 x 30 mm	320 mm	MNN-3
70 x 30 mm	330 mm	MNN-4



CALAFIORE

JAW LENGTH MAULLÄNGE	TOTAL LENGTH GESAMTLÄNGE	
70 mm	270 mm	MMV-0



DE BAKEY



COARCTATION FORCEPS  
COARCTATIONSKLEMMEN

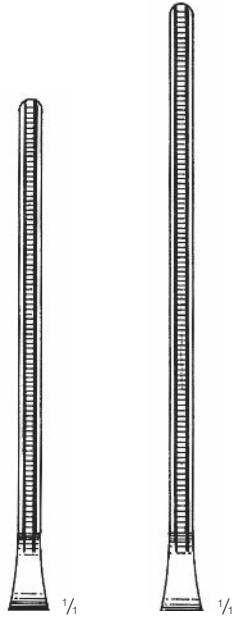

225 mm	240 mm
MAP-2	MAP-3
MBD-2	-

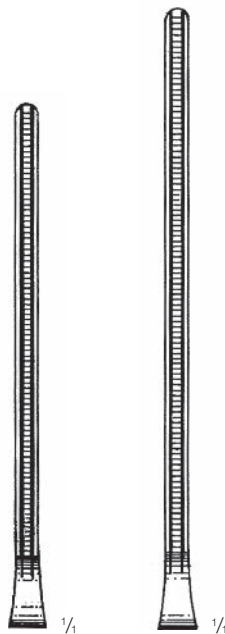

225 mm	240 mm
MAU-8	MAU-9



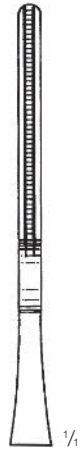

MEE-4  
MEP-2

PATENT-DUCTUS-FORCEPS  
PATENT-DUCTUS-KLEMMEN  
220 mm



MEE-3

PATENT-DUCTUS-FORCEPS  
PATENT-DUCTUS-KLEMMEN  
210 mm



240 mm	270 mm
MBG-7	MDY-9

WYLIE  
AORTIC FORCEPS  
AORTENKLEMMEN

AORTIC CLAMPS  
AORTENKLEMMEN



DE BAKEY

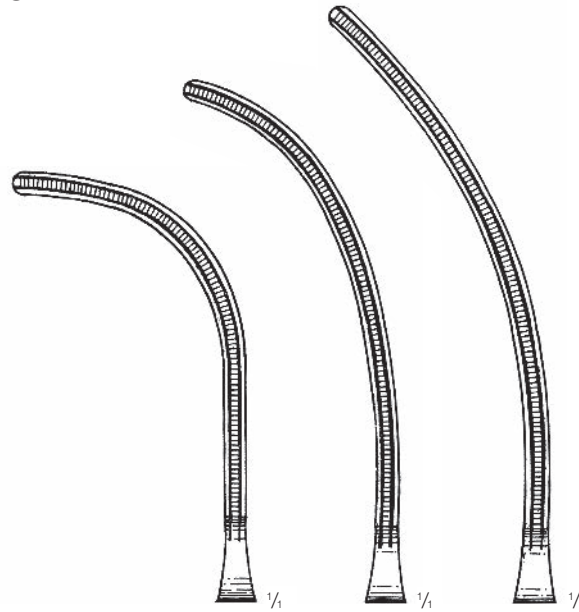

255 mm	265 mm	280 mm
MAT-7	MAT-8	MAT-9
MER-1	MER-2	MEZ-6



KAY  
200 mm

MAZ-2

DE BAKEY

AORTIC CLAMPS  
AORTENKLEMMEN



300 mm  
MAU-1

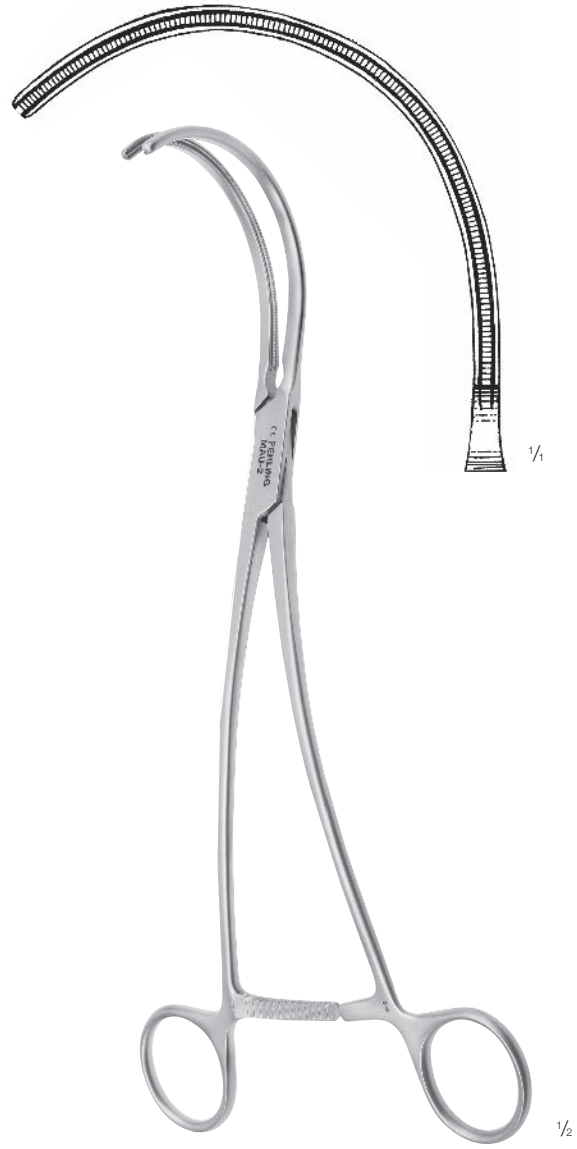

270 mm  
MAU-2

WEBER

VENA CAVA CLAMPS  
VENA CAVA KLEMMEN



RIGHT PATTERN  
RECHTSMODELL  
260 mm  
ZAU-3



LEFT PATTERN  
LINKSMODELL  
260 mm  
ZAU-2



PRICE THOMAS  
BRONCHUS FORCEPS  
BRONCHUSKLEMMEN  
220 mm

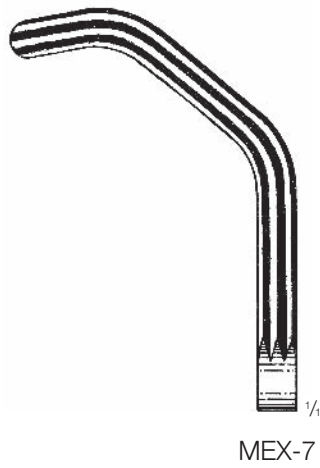

MEX-7

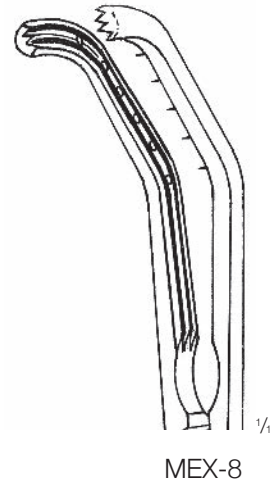

MEX-8



HACKER  
LOOP FORCEPS  
UMFÜHRUNGSKLEMME  
250 mm  
ZBZ-0



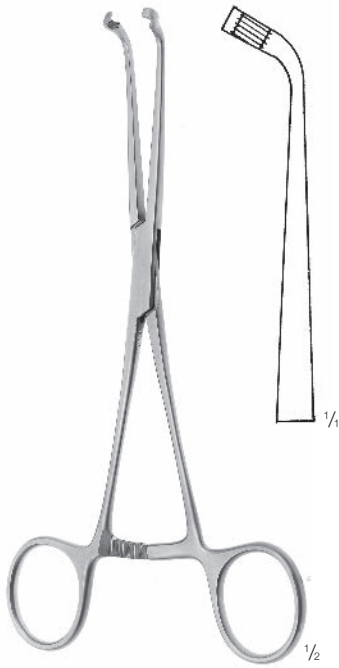

GUYON  
LOOP FORCEPS  
UMFÜHRUNGSKLEMME  
250 mm  
ZBZ-3



PRICE THOMAS  
CATHETER INTRODUCING FORCEPS  
KATHETEREINFÜHRZANGE  
170 mm  
MCP-7

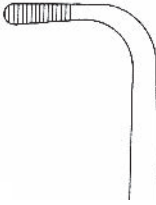
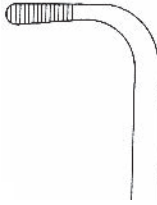

WATERSTON

			
180 mm	210 mm	170 mm	200 mm
DAY-7	DAY-9	DAY-6	DAY-8



BABY-ADSON  
185 mm  
DAZ-8



BABY-ADSON  
185 mm  
DCG-8

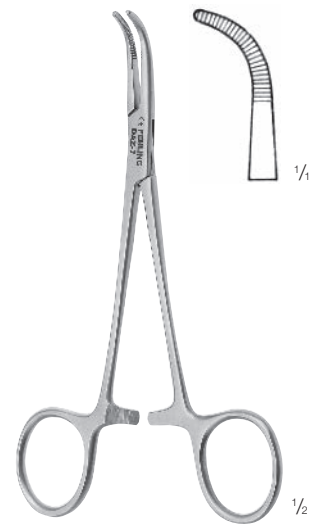

BABY-ADSON  
140 mm  
DAZ-7



150 mm	210 mm
DAW-0	DAV-0

CERAMO® RONDO  
MICRO LIGATURE FORCEPS  
MIKROLIGATURKLEMME



MICRO-ADSON  
140 mm  
DBK-6

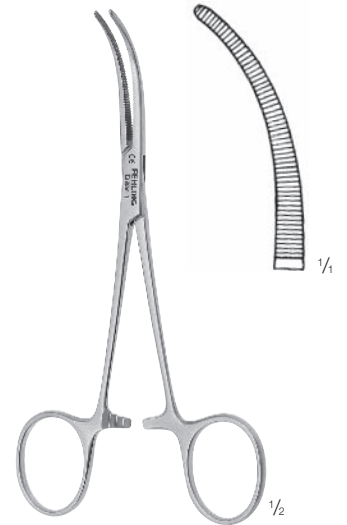

BABY-OVERHOLT  
135 mm  
DAV-1



BABY-MIXTER  
140 mm  
DBA-1



BABY-MIXTER  
180 mm  
DBA-2

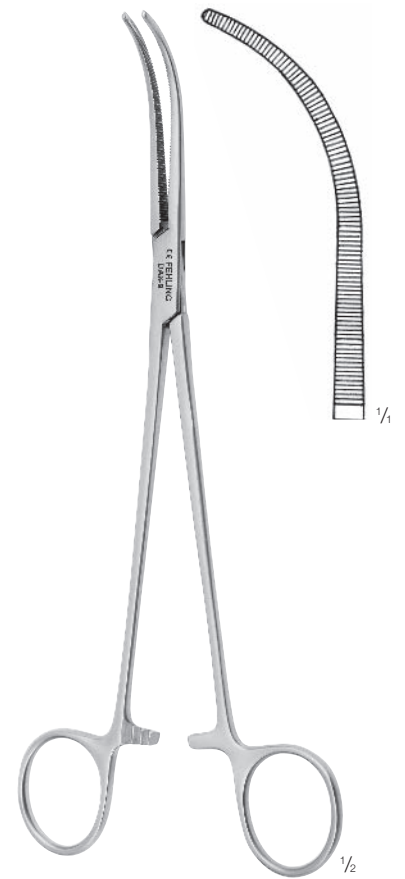

OVERHOLT-MIXTER  
230 mm  
DAX-9





HEISS

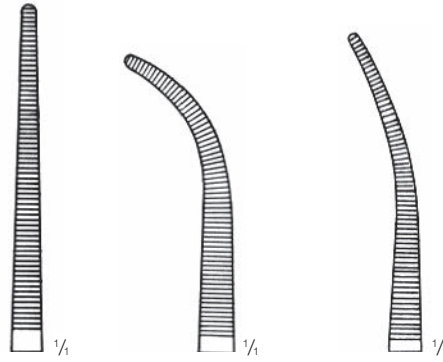

200 mm	205 mm	205 mm
DAG-1	DAG-3	DAG-4



MIXTER-O'SHAUGNESSY  
190 mm  
DCA-4

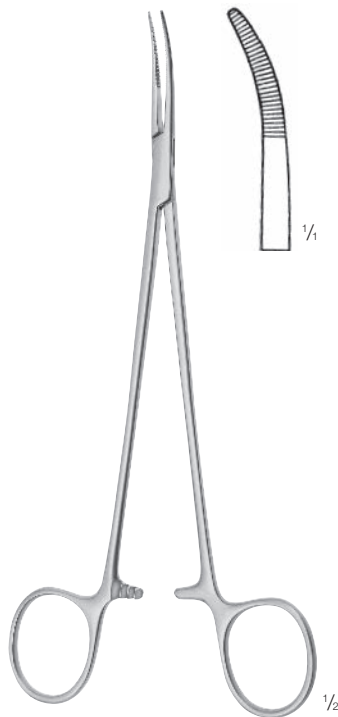

NISSEN  
190 mm  
DAL-6



WIKSTROEM  
210 mm  
DAZ-1



GEMINI

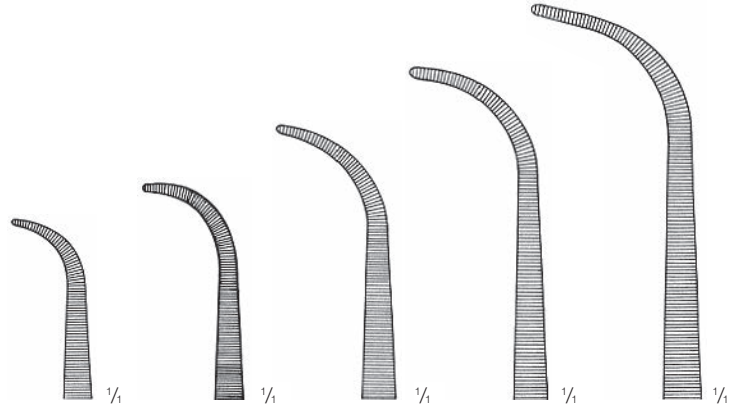

140 mm	180 mm	200 mm	230 mm	280 mm
DAV-2	DAV-3	DAV-4	DAV-5	DAV-6



RUMEL

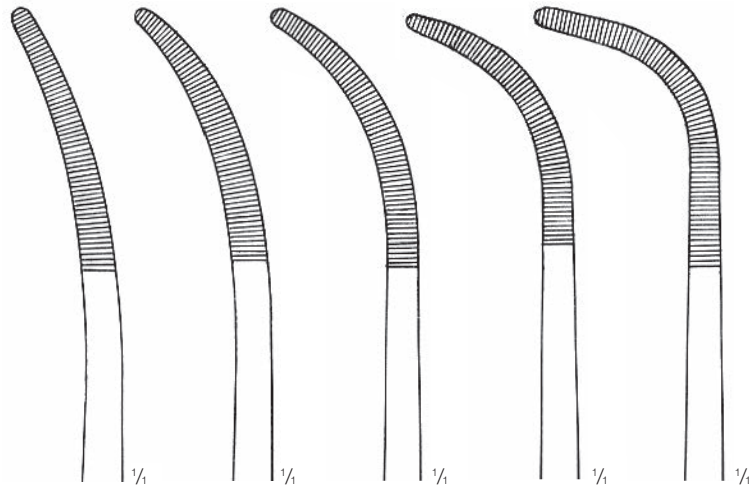

1	2	3	4	5
240 mm	240 mm	250 mm	240 mm	240 mm
DBK-7	DBK-8	DBK-9	DBL-1	DBL-2



OVERHOLT-GEISSENDOERFER

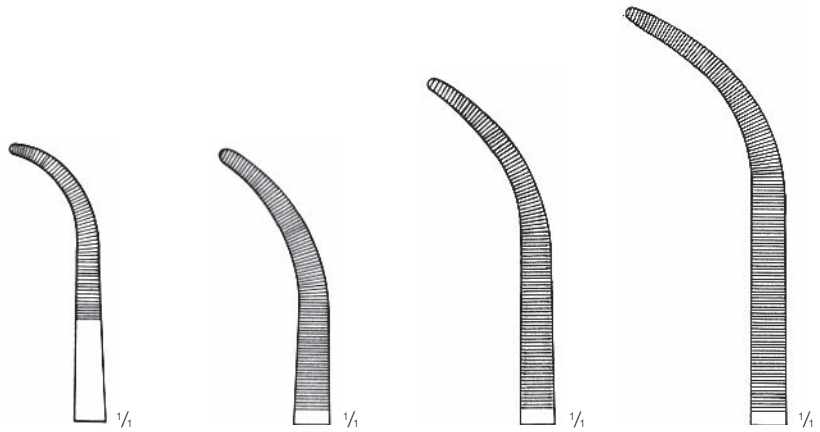

190 mm	270 mm	200 mm	270 mm	210 mm	270 mm	220 mm	270 mm
DAW-3	DAX-1	DAW-4	DAX-2	DAW-5	DAX-3	DAW-6	DAX-4

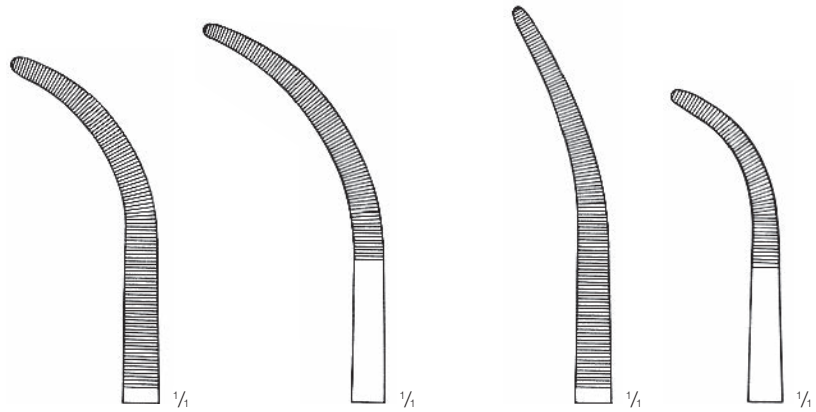

215 mm	270 mm	220 mm	270 mm	225 mm	270 mm	215 mm
DAW-7	DAX-5	DAW-8	DAX-6	DAW-9	DAX-7	ZAL-7

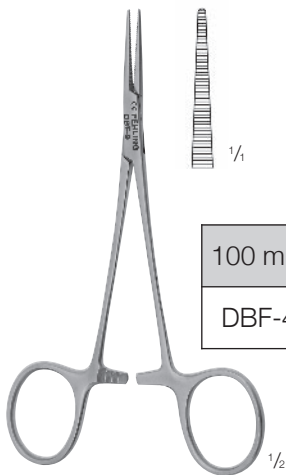

MICRO/MIKRO  
MOSQUITO

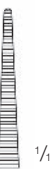

100 mm	120 mm
DBF-4	DBF-9

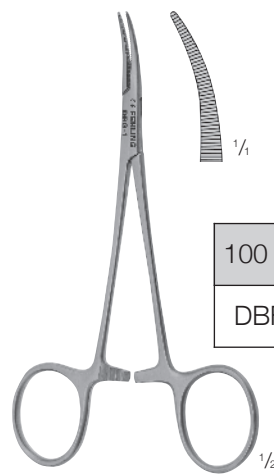

MICRO/MIKRO  
MOSQUITO



100 mm	120 mm
DBF-5	DBG-1

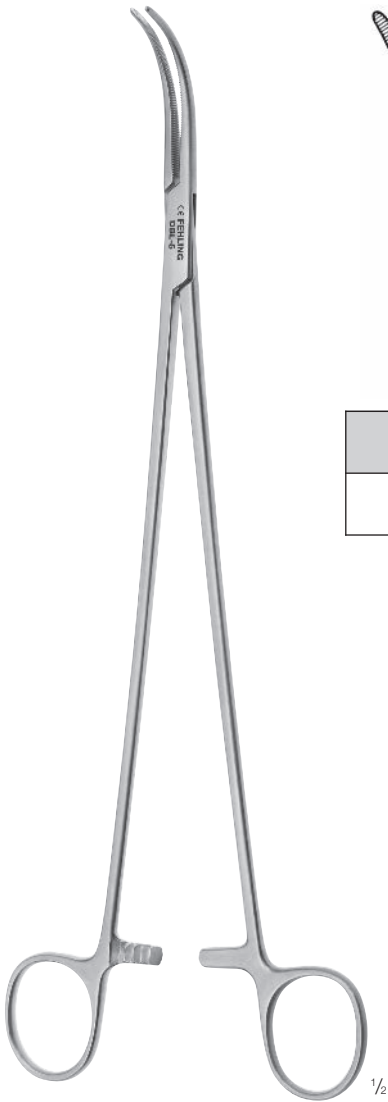

ZENKER

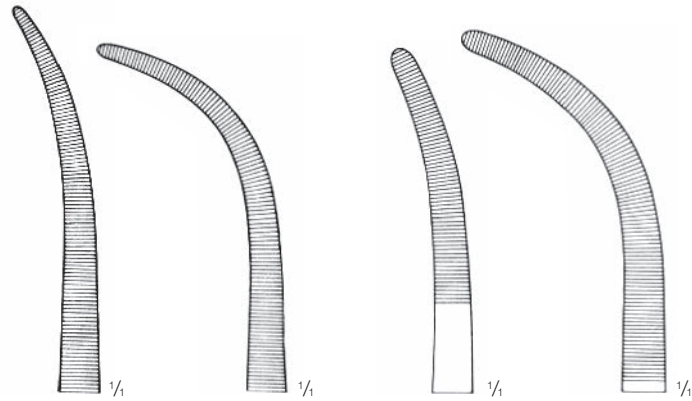

300 mm	285 mm	300 mm	300 mm
DBL-4	DBL-5	ZCD-9	ZCE-1



LIVERCLAMP  
LEBERKLEMME  
260 mm  
PAF-0

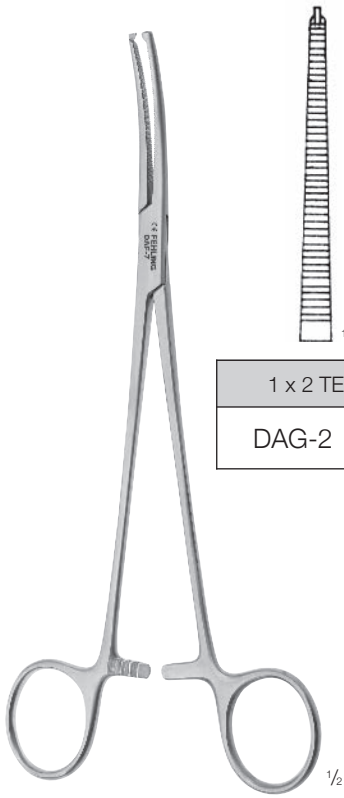

HEISS  
210 mm

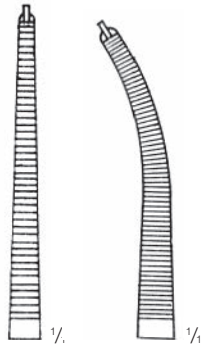

1 x 2 TEETH / ZÄHNE	
DAG-2	DAF-7

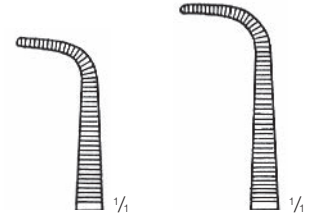

140 mm	180 mm
DAD-6	DAD-7



BENGOLEA

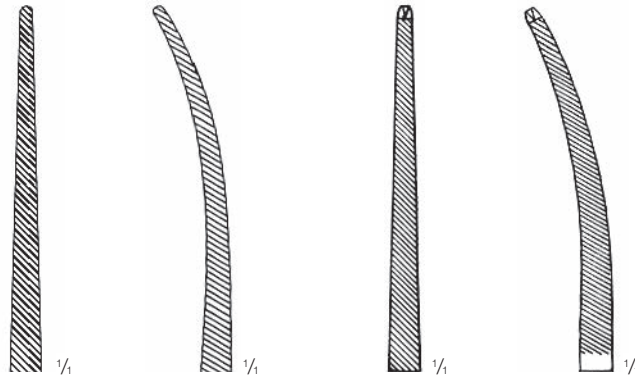

	1 x 2 TEETH / 1 x 2 ZÄHNE			
240 mm	DAA-6	DAA-7	DBZ-8	DAB-2
260 mm	DCC-8	DAA-9	DCC-6	DCC-7

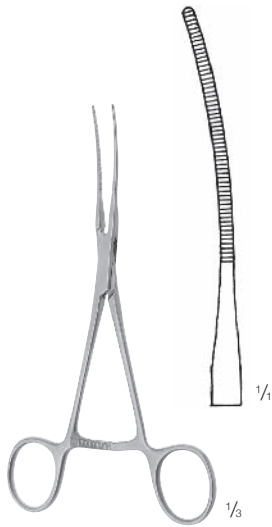

MILLS  
165 mm  
MFF-8



MILLS  
190 mm  
MFF-7

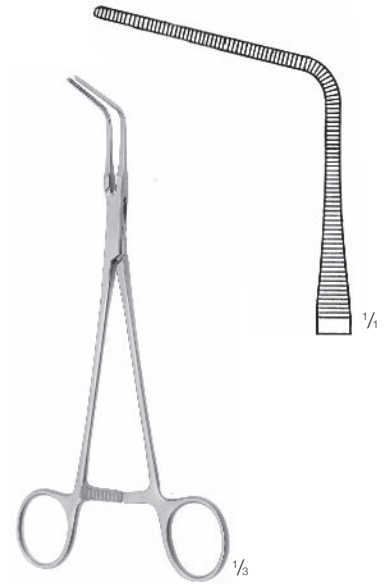

MILLS  
195 mm  
MFF-6



RUMEL  
230 mm  
ZAH-5



CRAFOORD  
240 mm  
DAB-8

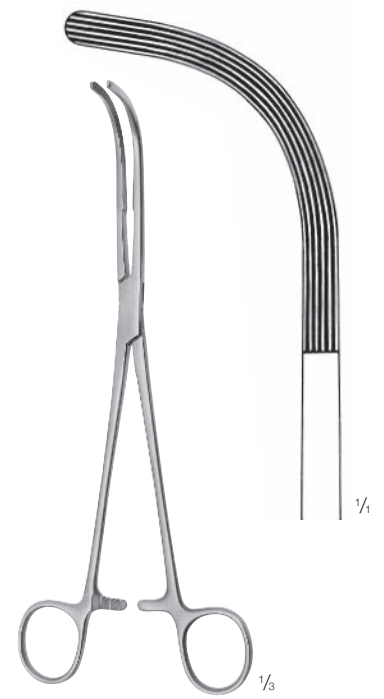

DE BAKY-CRAFOORD  
245 mm  
MAU-7

ALLIS



4 x 5 TEETH  
4 x 5 ZÄHNE

155 mm  
PAF-1



5 x 6 TEETH  
5 x 6 ZÄHNE



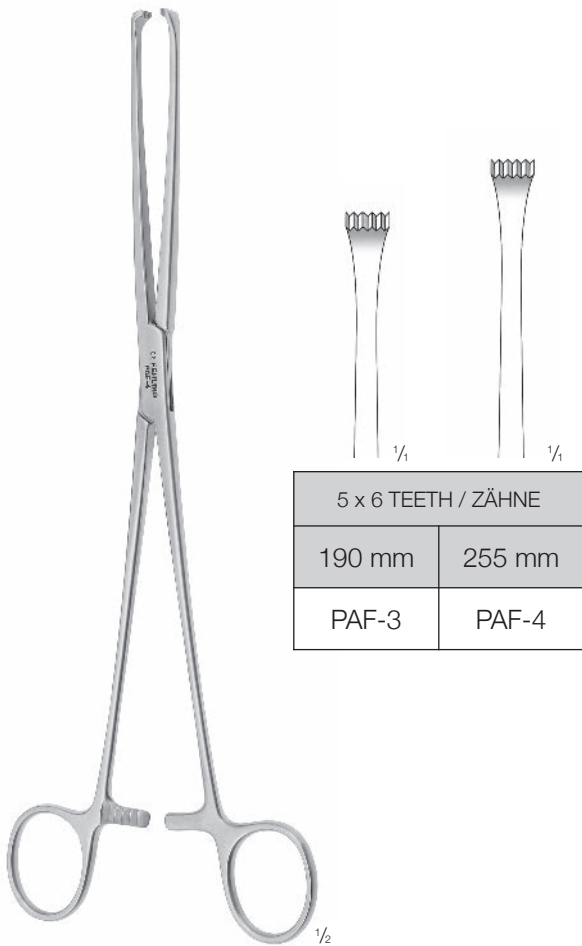

155 mm  
PAF-2



5 x 6 TEETH / ZÄHNE	
190 mm	255 mm
PAF-3	PAF-4





ALLIS  
NON-TRAUMATIC  
ATRAUMATISCH

				
155 mm	190 mm	230 mm	255 mm	300 mm
PAF-9	PAG-1	PAG-2	PAG-3	PAG-4

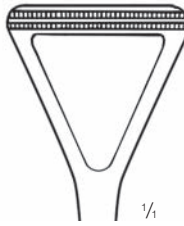

SCHEIBE

	
205 mm	230 mm
PAJ-4	PAJ-5





BABCOCK

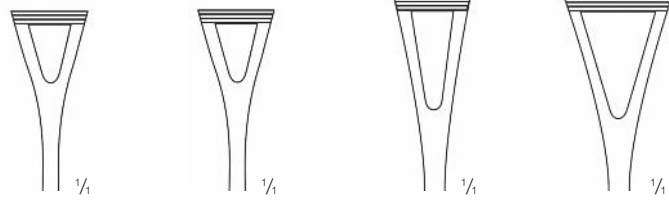

160 mm	170 mm	215 mm	240 mm
PAG-5	PAG-6	PAG-7	PAG-8



NON-TRAUMATIC  
ATRAUMATISCH

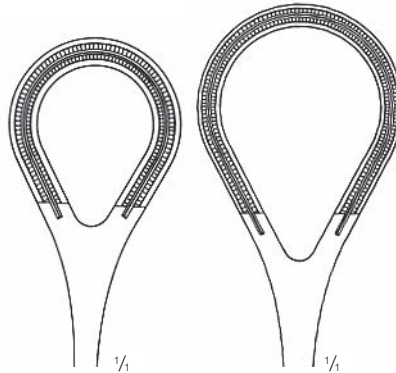

240 mm	270 mm
PAF-7	PAF-8



GROSS-MAIER

$\frac{1}{2}$

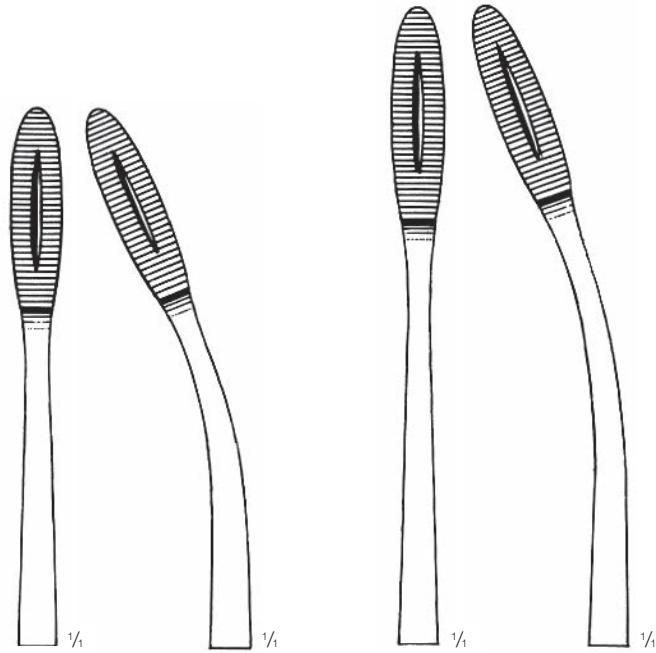

200 mm	200 mm	260 mm	260 mm
DBV-6	DBW-1	DBV-9	DBW-3



ULRICH

$\frac{1}{3}$

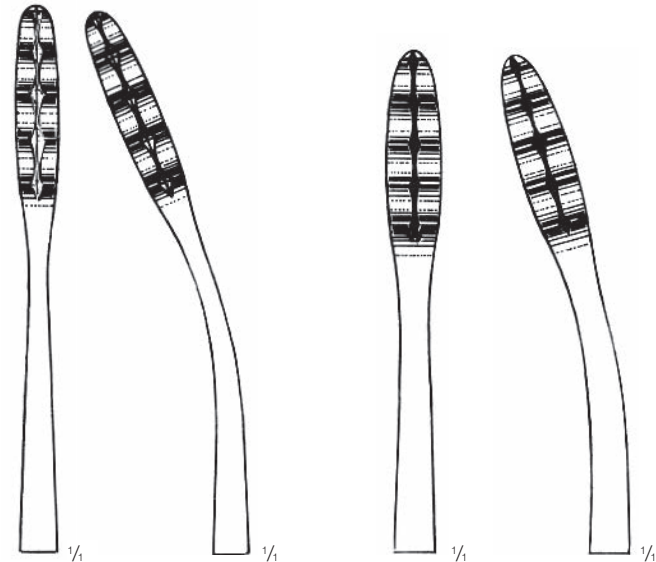

220 mm	220 mm	265 mm	265 mm
DBY-5	DBY-8	DBY-7	DBZ-1

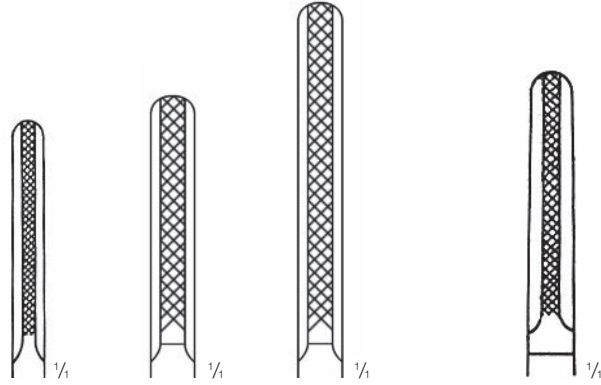

STANDARD			STRONG / STARK	
150 mm	180 mm	200 mm	190 mm	200 mm
ZAM-4	ZAM-3	DBM-2	DCG-9	DCN-6



WITH SAFETY GUARD  
MIT SCHUTZBÜGEL

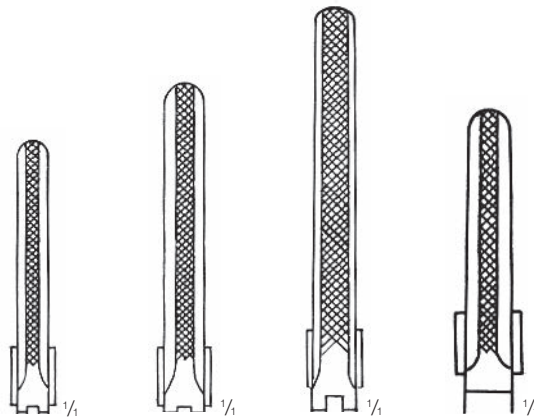

STANDARD			STRONG STARK
155 mm	180 mm	200 mm	190 m
DCB-6	DCB-7	DCB-8	DCH-1



FOR PAPER TOWELS  
FÜR PAPIERTÜCHER



135 mm  
DBP-5



145 mm  
DCM-7



145 mm  
DCM-8

for 1/2 inch tube  
für 1/2 Zoll-Schlauch



BACKHAUS

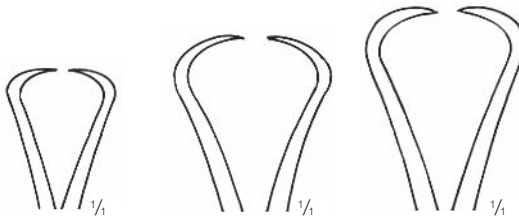

90 mm	110 mm	130 mm
DBM-5	DBM-6	DBM-7