

*FEHLING...
... THE DIFFERENCE*



9

RF SURGICAL
INSTRUMENTS

HF-CHIRURGISCHE
INSTRUMENTE

FEHLING
INSTRUMENTS

Hanauer Landstraße 7A · 63791 Karlstein/Germany · www.fehling-instruments.de



+49 (0) 61 88 - 95 74.40

















+49 (0) 61 88 - 95 74.45



info@fehling-instruments.de



CERAMO®





BALL ELECTRODES KUGELELEKTRODEN	Ø BALL KUGEL	TOTAL LENGTH GESAMTLÄNGE	Ø SHAFT SCHAFT	ITEM NO. ARTIKELNR.
 1/1	4,0 mm	50 mm	4,0 mm	WOE-4
 1/1	6,0 mm	50 mm	4,0 mm	WOE-6
 1/1	6,0 mm	130 mm	4,0 mm	WOK-5
 1/1	2,0 mm	50 mm	2,4 mm	WOJ-7
 1/1	4,0 mm	55 mm	2,4 mm	WOJ-8
 1/1	6,0 mm	50 mm	2,4 mm	WOD-6
 1/1	4,0 mm	130 mm	2,4 mm	WPA-4





NEEDLE ELECTRODES NADELELEKTRODEN	Ø NEEDLE NADEL	LENGTH/LÄNGE		Ø SHAFT SCHAFT	ITEM NO. ARTIKELNR.
		NEEDLE NADEL	TOTAL GESAMT		
 1/1	0,8 mm	25 mm	50 mm	4,0 mm	WOE-9
 1/1	0,7 mm	15 mm	55 mm	4,0 mm	WOJ-2
 1/1	0,8 mm	12 mm	140 mm	4,0 mm	WOJ-0
 1/1	0,8 mm	29 mm	80 mm	4,0 mm	WOJ-5
 1/1	0,5 mm	20 mm	70 mm	2,4 mm	WPB-5
 1/1	0,7 mm	20 mm	70 mm	2,4 mm	WPB-6
 1/1	0,7/0,5 mm	12 mm	150 mm	2,4 mm	WPB-8

 INSULATED
ISOLIERT

CERAMO®





LANCET ELECTRODES LANZETTELEKTRODEN	WIDTH BREITE	LENGTH/LÄNGE		Ø SHAFT SCHAFT	ITEM NO. ARTIKELNR.
		LANCET LANZETTE	TOTAL GESAMT		
 1/1	1,6 mm	19 mm	45 mm	4,0 mm	WOI-1
 1/1	1,5 mm	17 mm	50 mm	4,0 mm	WOE-1





KNIFE ELECTRODES MESSERELEKTRODEN	WIDTH BREITE	LENGTH/LÄNGE		Ø SHAFT SCHAFT	ITEM NO. ARTIKELNR.
		KNIFE MESSER	TOTAL GESAMT		
 1/1	3,3 mm	25 mm	60 mm	4,0 mm	WOK-4
 1/1	2,5 mm	20 mm	50 mm	4,0 mm	WOJ-3
	2,4 mm	20 mm	150 mm	4,0 mm	WOJ-6
 1/1					
 1/1	3,3 mm	24 mm	55 mm	4,0 mm	WOE-3

SPATULA ELECTRODES SPATELELEKTRODEN	WIDTH BREITE	LENGTH/LÄNGE		Ø SHAFT SCHAFT	ITEM NO. ARTIKELNR.
		SPATULA SPATEL	TOTAL GESAMT		
 1/1	3,0 mm	24 mm	55 mm	4,0 mm	WOE-2
TIP MALLEABLE SPITZE BIEGSAM	2,0 mm	16 mm	100 mm	4,0 mm	WOJ-1
 1/1					
 1/1	2,5 mm	20 mm	70 mm	2,4 mm	WOE-8
	2,5 mm	20 mm	160 mm	2,4 mm	WPB-7
 1/1					

 INSULATED
ISOLIERT

CERAMO®

WIRE LOOP ELECTRODES DRAHTSCHLINGENELEKTRODEN	Ø LOOP SCHLINGE	TOTAL LENGTH GESAMTLÄNGE	Ø SHAFT SCHAFT	ITEM NO. ARTIKELNR.
 1/1	5,0 mm	45 mm	4,0 mm	WOI-7
 1/1	10,0 mm	50 mm	4,0 mm	WOI-8
 1/1	5,0 mm	55 mm	2,4 mm	WOJ-9
 1/1	10,0 mm	60 mm	2,4 mm	WPB-3

RIBBON LOOP ELECTRODES BANDSCHLINGENELEKTRODEN	Ø LOOP SCHLINGE	TOTAL LENGTH GESAMTLÄNGE	Ø SHAFT SCHAFT	ITEM NO. ARTIKELNR.
 1/1	12,0 mm	50 mm	4,0 mm	WOJ-4
 1/1	10,0 mm	50 mm	4,0 mm	WOK-1
 1/1	15,0 mm	50 mm	4,0 mm	WOK-2
 1/1	10,0 mm	60 mm	2,4 mm	WPB-4

 INSULATED
ISOLIERT

MONOPOLAR ABLATION INSTRUMENT
MONOPOLARES ABLATIONSINSTRUMENT



SINGLE USE ELECTRODE
EINMAL-ELEKTRODE

WAT-6

HANDLE, REUSABLE
HANDSTÜCK, WIEDERVERWENDBAR
270 mm

WAT-1

PACKAGING SIZE: 10 PIECES
PACKUNGSGRÖSSE: 10 STÜCK

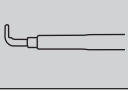
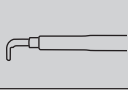

		
220 mm	WAS-1	WAS-2
260 mm	WAS-3	WAS-4

DITTMANN
 BIPOLAR COAGULATION ELECTRODE
 BIPOLARE KOAGULATIONSELEKTRODE

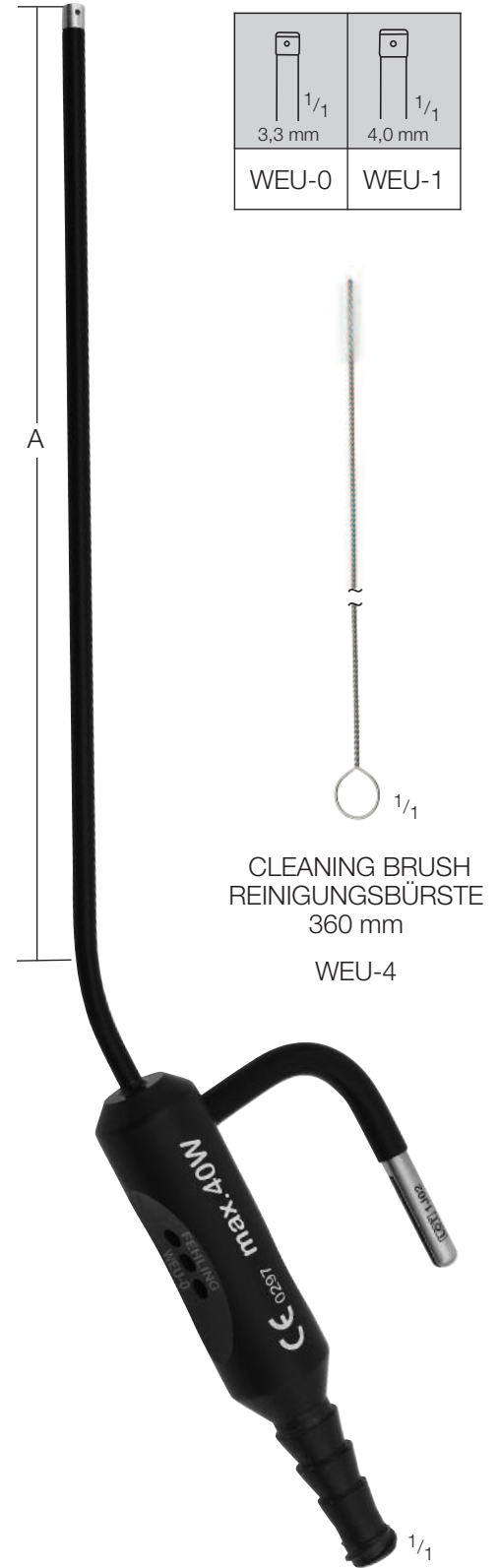

NON-STICK
 MONOPOLAR SUCTION TUBE
 MONOPOLARER SAUGER
 A = 130 mm



0,5 mm

1/1

CERAMO®
105 mm
WOM-3



2,0 mm



1/1



CERAMO®
195 mm
WOI-0



1/1

105 mm

		CERAMO®	UNCOATED UNBESCHICHTET
	0,3 mm POINTED/SPITZ	WOM-1	ZAY-4
	0,5 mm	WOM-2	ZAY-5
	1,0 mm	WOM-4	ZAY-9
	0,3 mm POINTED/SPITZ	WOM-5	ZAY-6
	0,3 mm POINTED/SPITZ	WOM-6	ZAY-7
	0,5 mm	WOM-7	ZAY-8
	1,0 mm	WOM-8	ZAY-0



		CERAMO®	UNCOATED UNBESCHICHTET
	0,3 mm POINTED/SPITZ	WOH-5	ZAX-4
	1,0 mm	WOH-7	ZAX-5
	1,0 mm	WOH-8	ZAX-6
	2,0 mm	WOH-9	ZAX-7



165 mm



*DELICATE/FEIN
165 mm

		CERAMO®	UNCOATED UNBESCHICHTET
	0,3 mm POINTED/SPITZ	WOH-1	ZAW-6
	1,0 mm	WOH-3	ZAW-7
	0,3 mm POINTED/SPITZ	WOH-0	ZAX-0
	1,0 mm	WOH-4	ZAW-9
	0,3 mm DELICATE/FEIN*	WOH-2	ZAW-8



195 mm

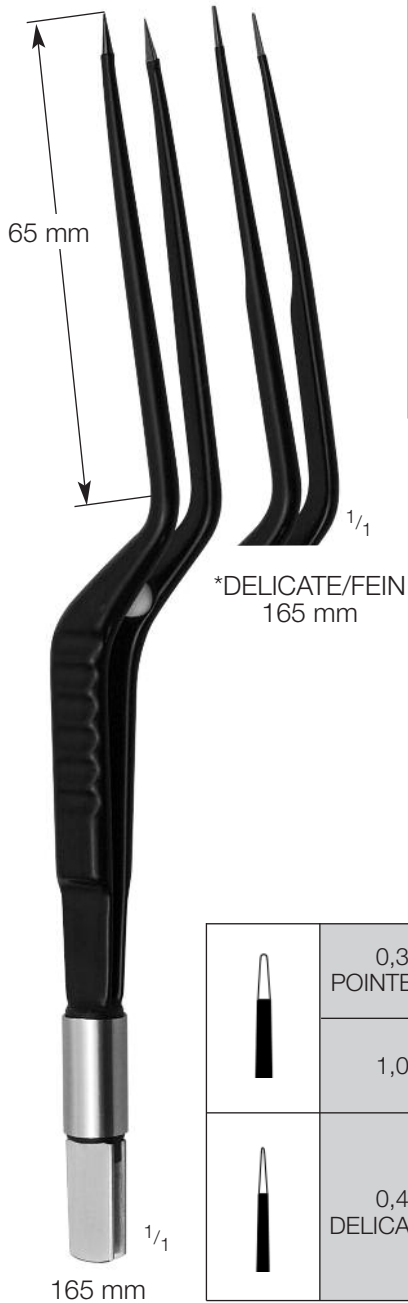

		CERAMO®	UNCOATED UNBESCHICHTET
	0,3 mm POINTED/SPITZ	WOG-3	ZAX-8
	1,0 mm	WOG-1	ZAX-9
	2,0 mm	WOG-2	ZAY-1
	0,7 mm	WOM-0	ZEF-1
	1,2 mm	WOG-9	ZEF-2
	1,0 mm	WOG-7	ZAY-2
	0,7 mm	WOL-9	ZEF-3
	1,2 mm	WOM-9	ZEF-4
	1,0 mm	WOG-6	ZAY-3





		CERAMO®	UNCOATED UNBESCHICHTET
	0,3 mm POINTED/SPITZ	WON-2	ZAX-2
	1,0 mm	WON-3	ZAX-3
	0,4 mm DELICATE/FEIN*	WON-1	ZAX-1



220 mm

¹/₁

		CERAMO®	UNCOATED UNBESCHICHTET
	1,0 mm	WOL-4	ZEE-3
	2,0 mm	WOL-7	ZEG-9
	2,2 mm	WOL-3	WOL-5

		CERAMO®	UNCOATED UNBESCHICHTET
	1,0 mm	WOL-1	ZEG-1
	2,0 mm	WOL-2	WOL-6



300 mm

²/₃

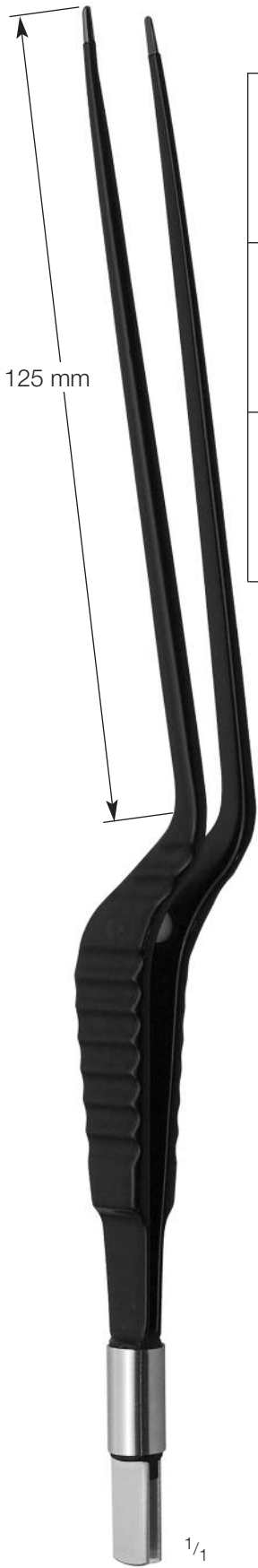

230 mm

1/1

		CERAMO®	UNCOATED UNBESCHICHTET
	0,7 mm	WOP-9	ZES-1
	1,2 mm	WOP-7	ZDP-4
	0,7 mm	WOR-0	ZEF-0
	0,7 mm	WOP-8	ZEE-7
	1,2 mm	WOP-6	ZEE-6

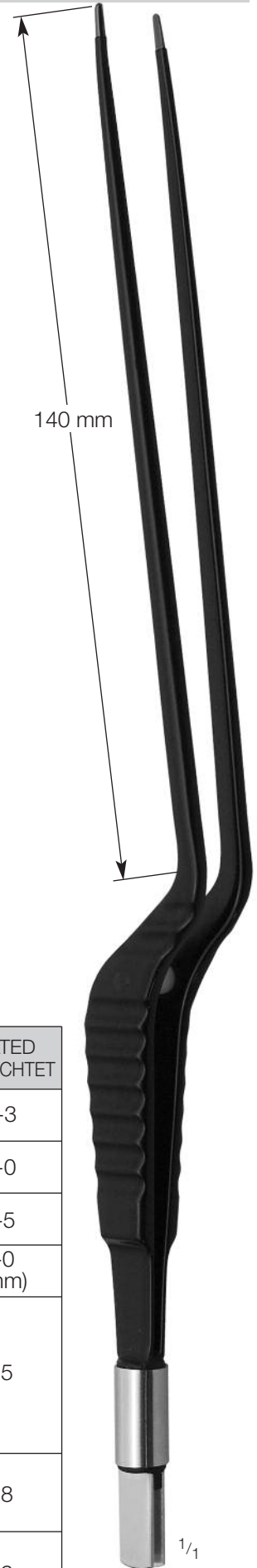

240 mm



1/1

		CERAMO®	UNCOATED UNBESCHICHTET
	0,3 mm POINTED/SPITZ	WOG-4	CDN-3
	0,7 mm	WOP-4	CCA-0
	1,2 mm	WOG-5	ZCC-5
	2,0 mm	WOG-8 (250 mm)	ZEG-0 (250 mm)
	1,2 mm	WOP-5	ZEE-5
	0,7 mm	WOP-1	ZEE-8
	1,2 mm	WOP-2	ZEE-9



CERAMO®

FLUSHING FORCEPS
SPÜLPINZETTEN

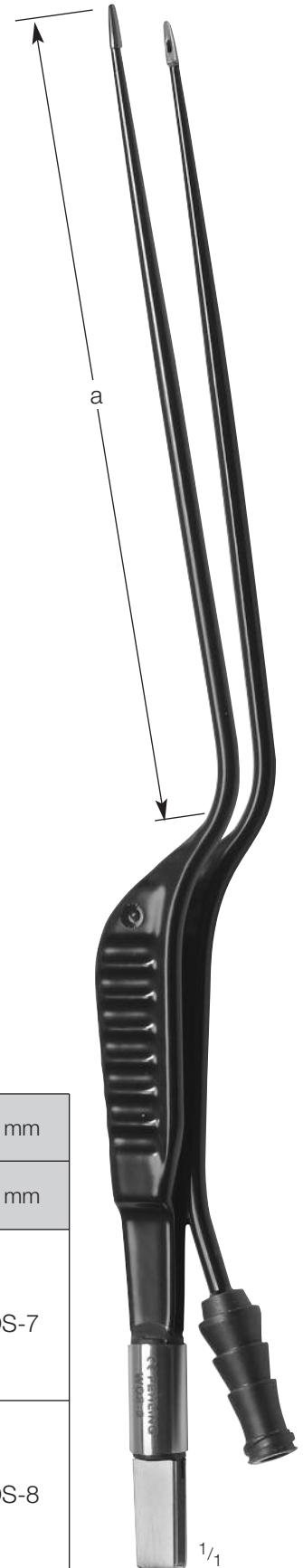

	200 mm	230 mm	250 mm
 1,5 mm ONE-SIDED EINSEITIG	WOS-1	WOS-2	WOS-3
 1,5 mm BOTH-SIDED BEIDSEITIG		WOS-4	











LENGTH -a- LÄNGE -a-	85 mm	115 mm
TOTAL LENGTH GESAMTLÄNGE	200 mm	230 mm
 0,5 mm	WOS-5	WOS-7
 1,0 mm	WOS-6	WOS-8





ONE-SIDED
EINSEITIG

BOTH-SIDED
BEIDSEITIG

BIPOLAR

PLUG UNIT SIDE STECKER GERÄTESEITE	CABLE LENGTH KABELLÄNGE	SAFTY PLUG INSTRUMENT SIDE SICHERHEITSSTECKER INSTRUMENTENSEITE	
		 STRAIGHT GERADE	 ANGLED GEWINKELT
 ERBE, STORZ, WOLF	4,5 m	ZAW-5	ZAW-5G
 VALLEYLAB, SUTTER (CURIS)	4,5 m	ZGA-7	ZAW-7G
 MARTIN, BERCHTOLD, AESCULAP, SUTTER (BM 780)	4,5 m	ZAW-2	ZAW-2G
 CODMAN (OLD UNITS / ALTE GERÄTE)	4,5 m	ZAW-1	-
 AESCULAP (OLD UNITS / ALTE GERÄTE)	4,5 m	ZAV-0	-
 US UNITS / AMERIKANISCHE GERÄTE, SUTTER (CURIS) <small>not allowed in Germany and France in Deutschland und Frankreich nicht erlaubt</small>	4,5 m	WNS-0	WNS-OG

MONOPOLAR

PLUG UNIT SIDE STECKER GERÄTESEITE	CABLE LENGTH KABELLÄNGE	PLUG INSTRUMENT SIDE STECKER INSTRUMENTENSEITE
		 TOUCH SAFE BERÜHRSICHER
 MARTIN, BERCHTOLD, AESCULAP, ERBE T-SERIE, SUTTER (BM780)	3,5 m	ZAV-5
 ERBE ACC/ ICC/ VIO, STORZ, WOLF	3,5 m	ZAV-3
 US UNITS / AMERIKANISCHE GERÄTE, SUTTER (CURIS)	3,5 m	ZAV-4